

## KNO12-B-PP INA

Linear bushing

TYPE: Shaft guidance systems, Linear bushing, Self aligning, Open type for support rail, Type KNO..B-PP, light range, sealed on both sides (INA)

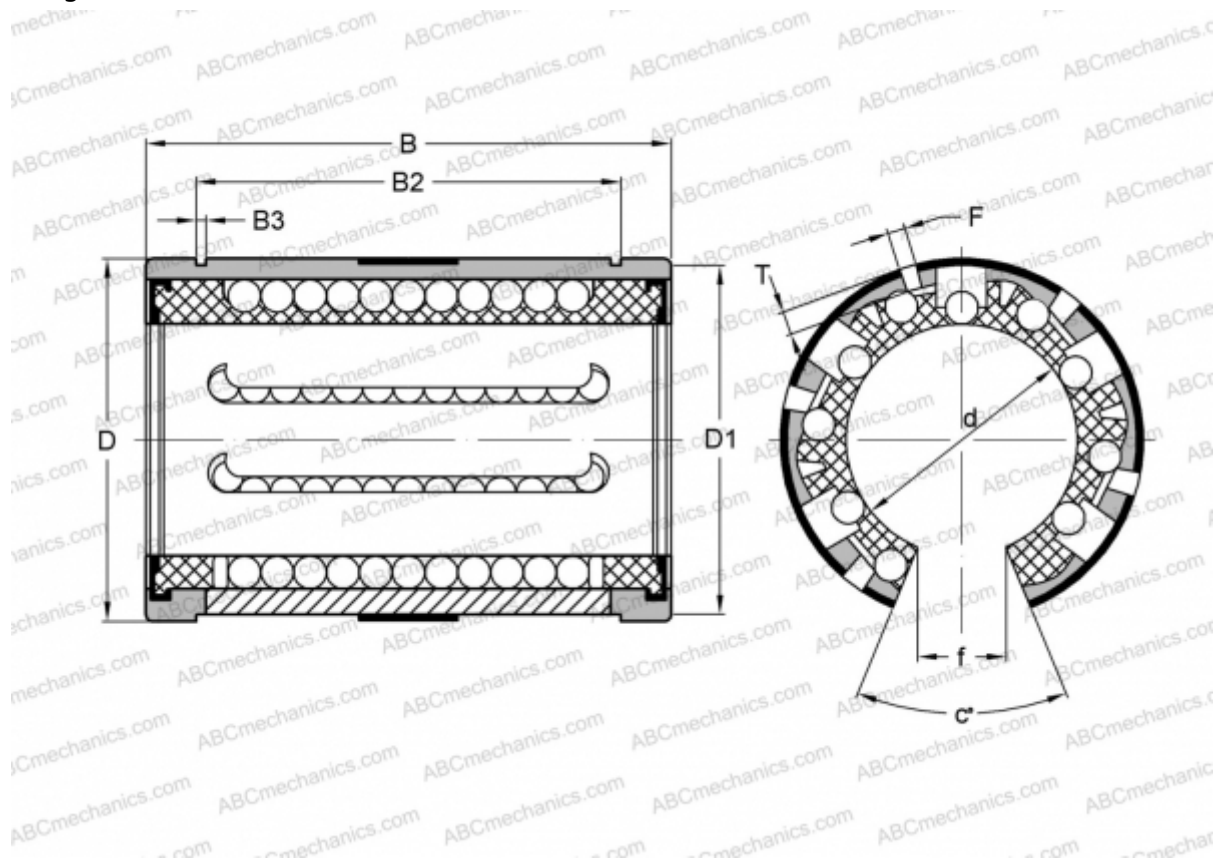

### Technical specification

#### DIMENSIONS, MM

d	12,000
D	22,000
B	32,000
T	0,700
f	6,500
c	66
F	3

**WEIGHT, KG** 0,020

**MANUFACTURER** [INA](http://www.ina.com)