

KNO20-B-PP INA

Linear bushing

TYPE: Shaft guidance systems, Linear bushing, Self aligning, Open type for support rail, Type KNO..B-PP, light range, sealed on both sides (INA)

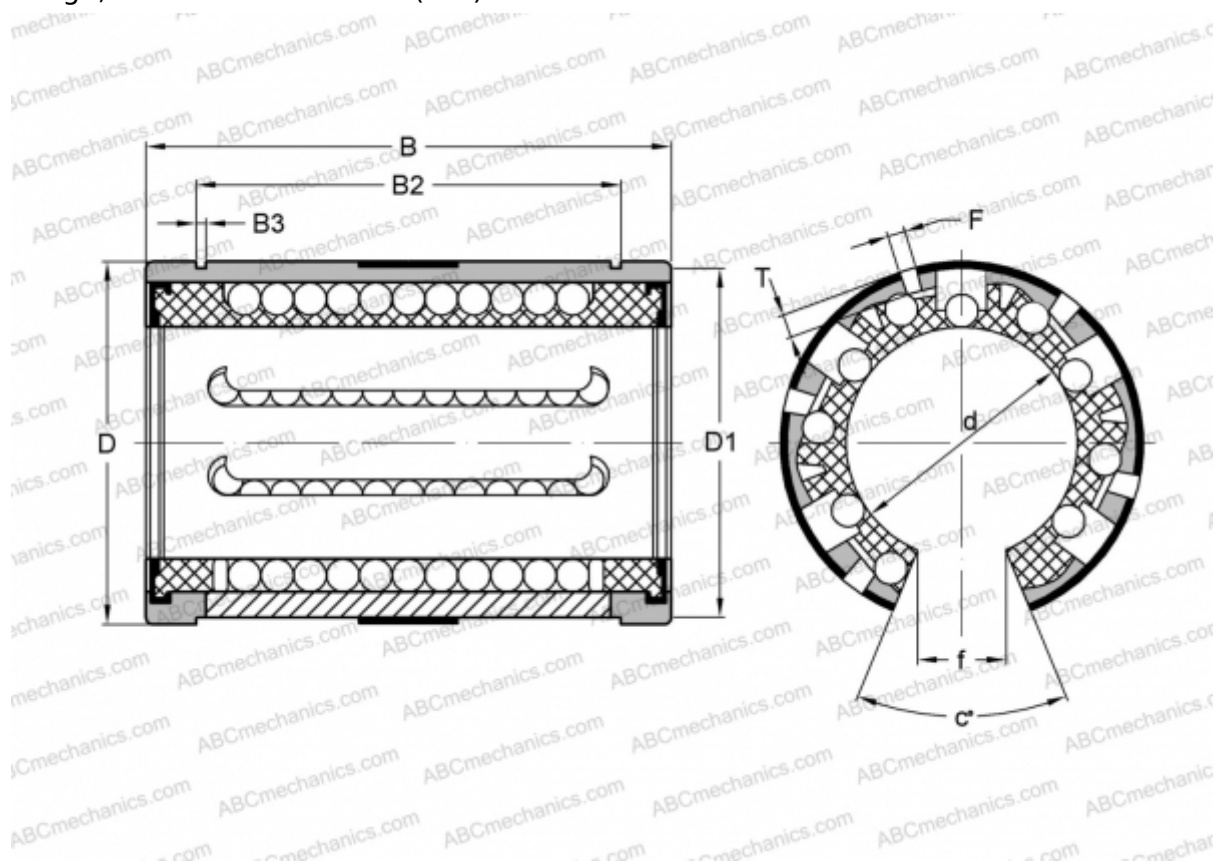

Technical specification

DIMENSIONS, MM

d	20,000
D	32,000
B	45,000
T	0,900
f	9,000
c	55
F	3

WEIGHT, KG 0,050

MANUFACTURER [INA](http://www.ina.com)