

KNO30-B-PP INA

Linear bushing

TYPE: Shaft guidance systems, Linear bushing, Self aligning, Open type for support rail, Type KNO..B-PP, light range, sealed on both sides (INA)

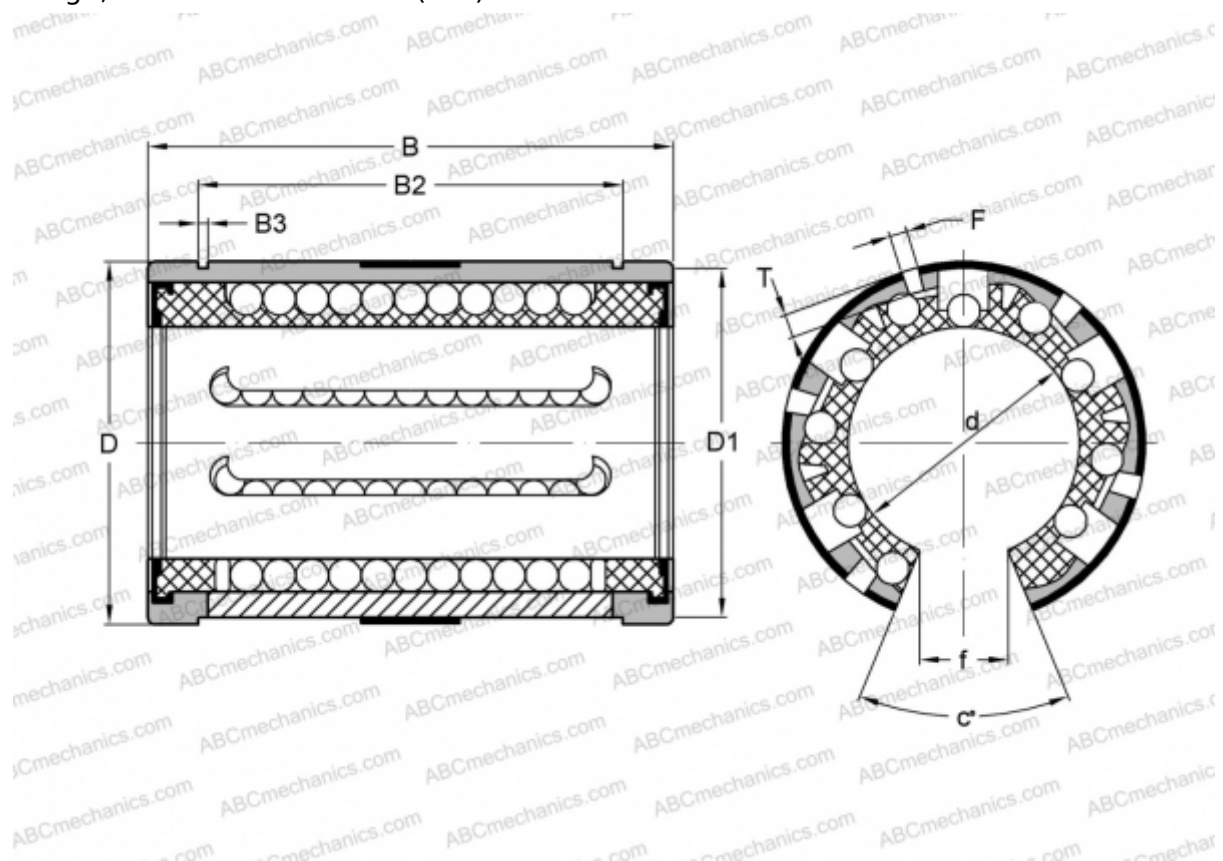

Technical specification

DIMENSIONS, MM

d	30,000
D	47,000
B	68,000
T	2,200
f	14,000
c	57
F	3

WEIGHT, KG 0,160

MANUFACTURER [INA](http://www.ina.com)