

KSO20-PP INA

Linear bushing

TYPE: Shaft guidance systems, Linear bushing, Self aligning, Open type for support rail, Type KSO..PP, heavy duty range, sealed on both sides (INA)

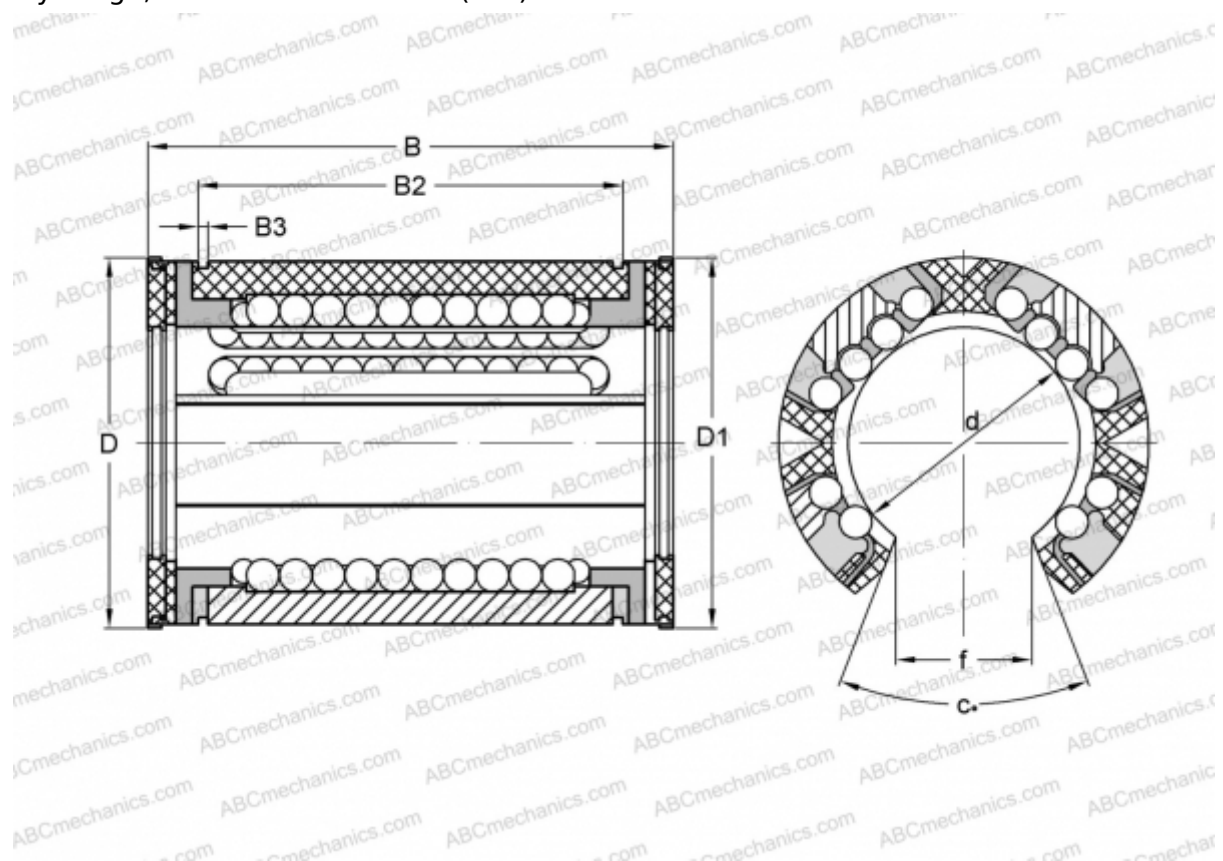

Technical specification

DIMENSIONS, MM

d	20,000
D	32,000
B	45,000
f	10,000
c	60

WEIGHT, KG 0,038

MANUFACTURER [INA](#)