

KSO30-PP INA

Linear bushing

TYPE: Shaft guidance systems, Linear bushing, Self aligning, Open type for support rail, Type KSO..PP, heavy duty range, sealed on both sides (INA)

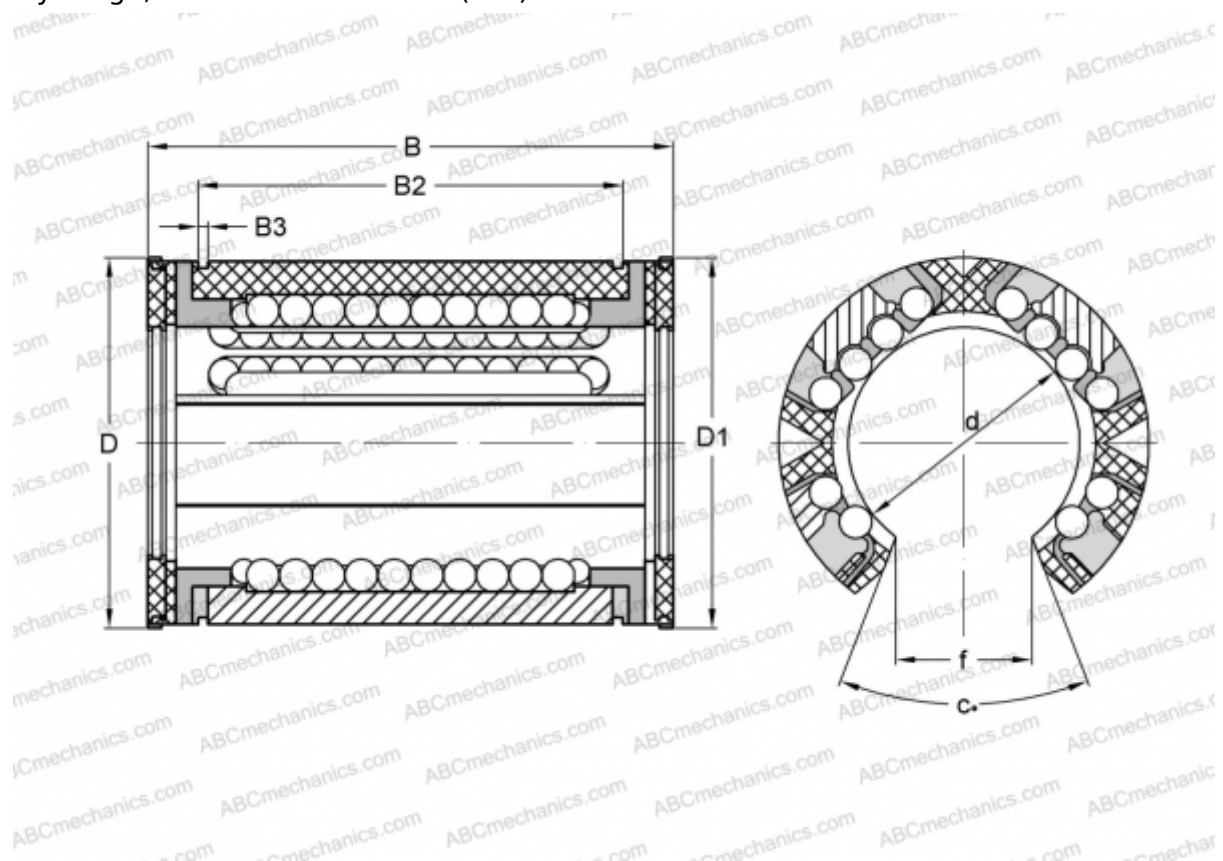

Technical specification

DIMENSIONS, MM

d	30,000
D	47,000
B	68,000
f	14,300
c	57

WEIGHT, KG 0,135

MANUFACTURER [INA](#)