

KSO40-PP INA

Linear bushing

TYPE: Shaft guidance systems, Linear bushing, Self aligning, Open type for support rail, Type KSO..PP, heavy duty range, sealed on both sides (INA)

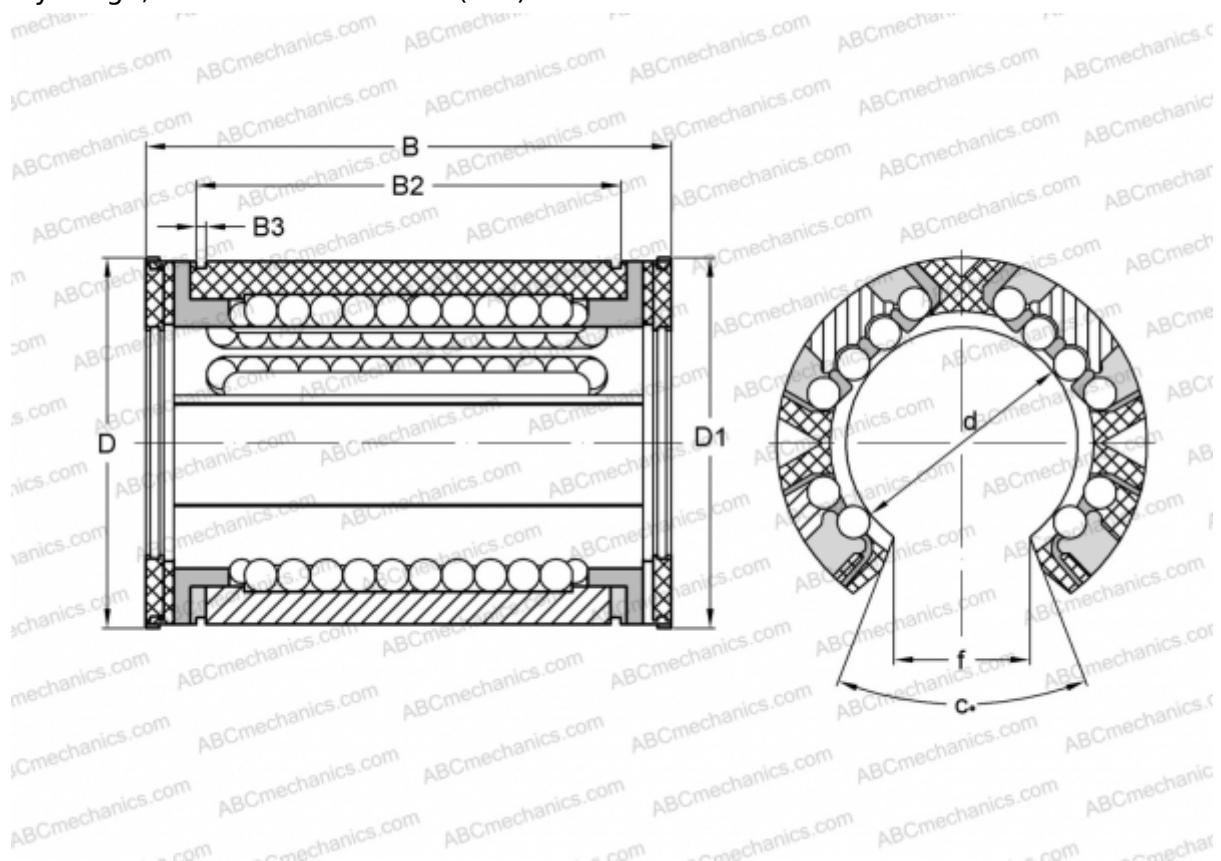

Technical specification

DIMENSIONS, MM

d	40,000
D	62,000
B	80,000
f	18,200
c	54

WEIGHT, KG 0,259

MANUFACTURER [INA](#)