

KXO12-PP INA

Linear bushing

TYPE: Shaft guidance systems, Linear bushing, Self aligning, Open type for support rail, Type KXO..PP, heavy duty range, sealed on both sides, inch size (INA)

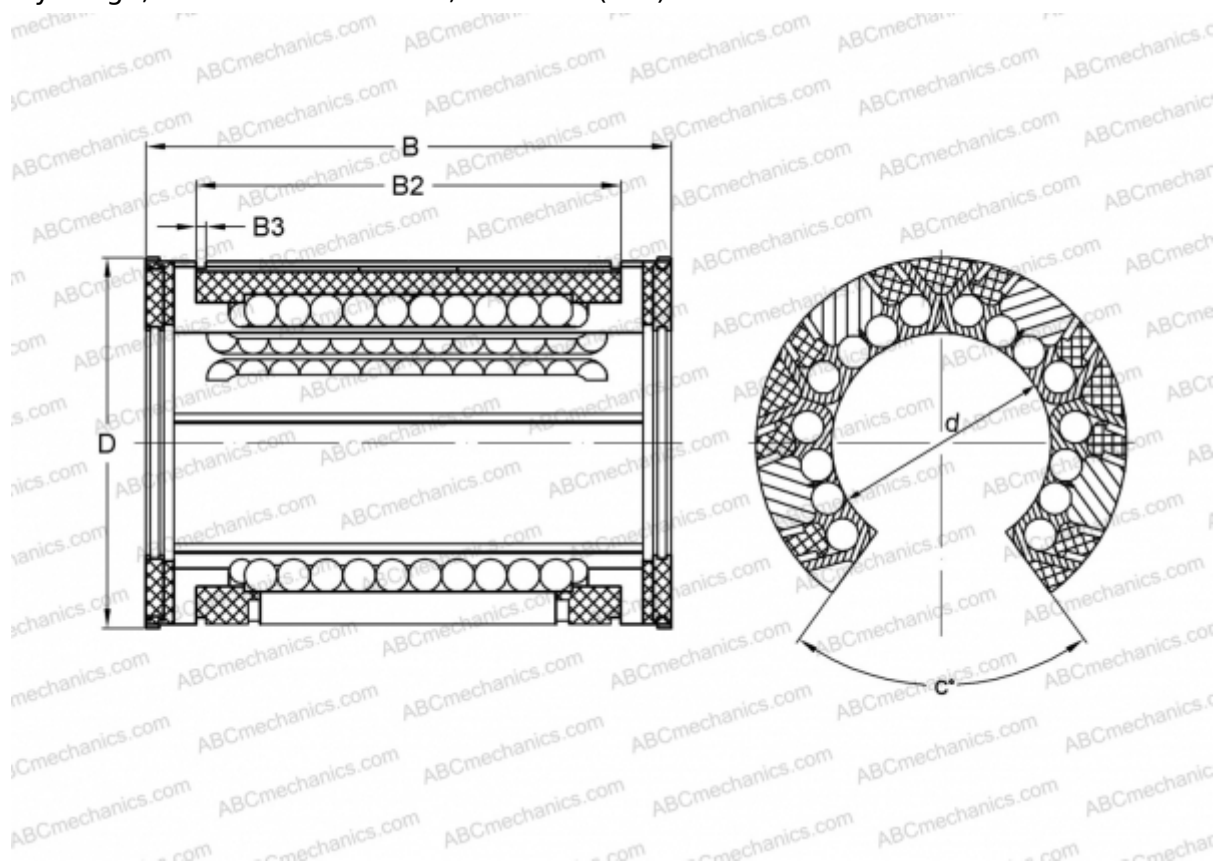

Technical specification

DIMENSIONS, MM

d	19,050
D	31,750
B	41,275
B2	32,309
B3	1,422
c	60

WEIGHT, KG 0,053

MANUFACTURER [INA](#)