

## KX032-PP INA

Linear bushing

TYPE: Shaft guidance systems, Linear bushing, Self aligning, Open type for support rail, Type KXO..PP, heavy duty range, sealed on both sides, inch size (INA)

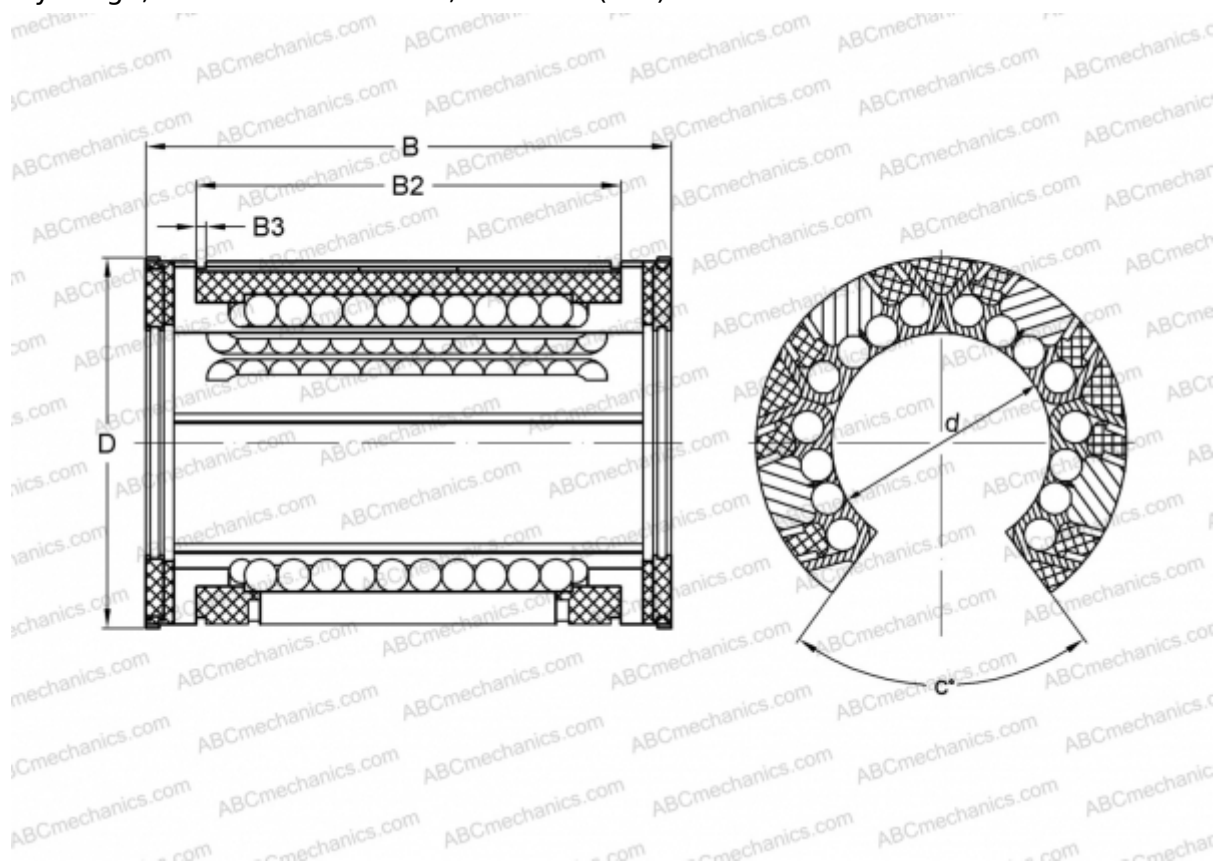

### Technical specification

#### DIMENSIONS, MM

d	50,800
D	76,200
B	101,600
B2	81,432
B3	2,616
c	60

**WEIGHT, KG** 0,434

**MANUFACTURER** [INA](#)