

KB20-PP-AS INA

Linear bushing

TYPE: Shaft guidance systems, Linear bushing, Standard, Close type, Type KB..PP-AS, machined range, sealed on both sides, with relubrication facility (INA)

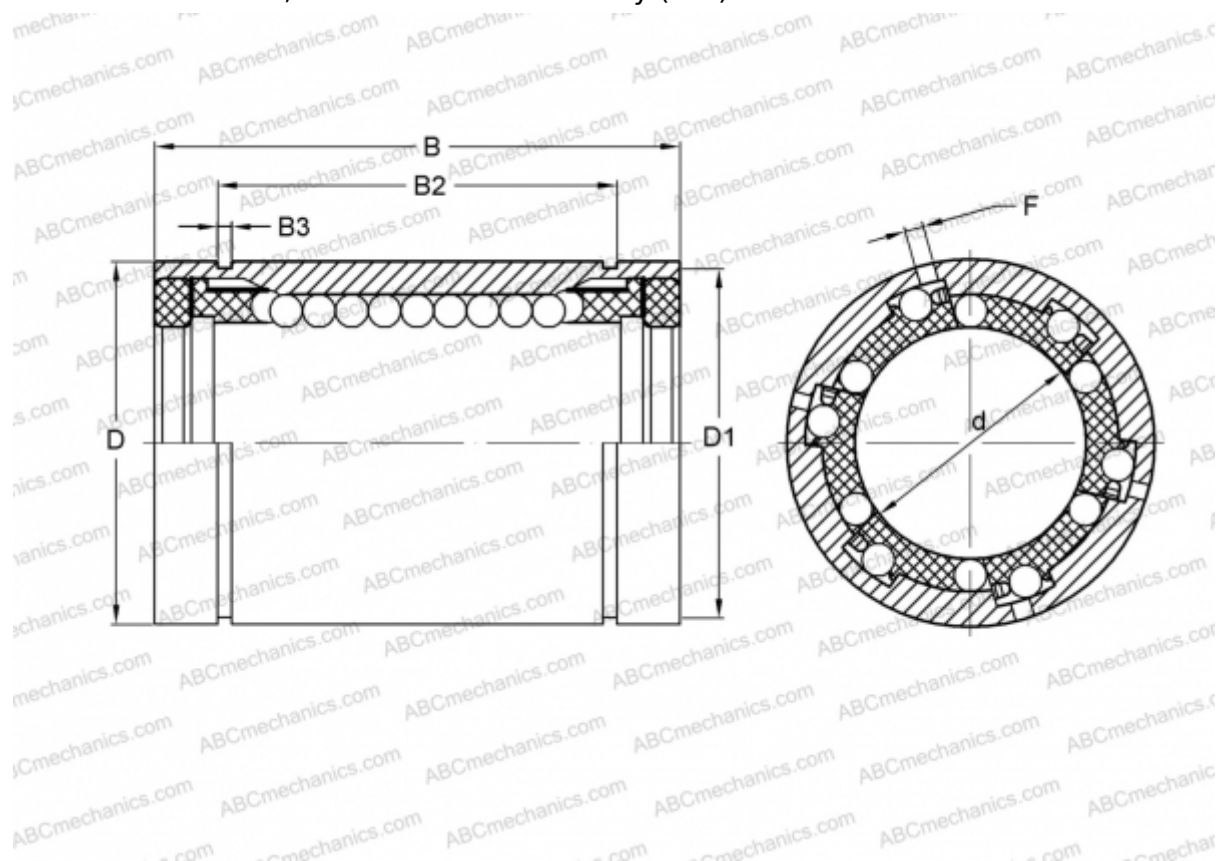

Technical specification

DIMENSIONS, MM

d	20,000
D	32,000
B	45,000
D1	30,300
B2	31,200
B3	1,600
F	2

WEIGHT, KG 0,090

MANUFACTURER [INA](#)