

KB25-PP-AS INA

Linear bushing

TYPE: Shaft guidance systems, Linear bushing, Standard, Close type, Type KB..PP-AS, machined range, sealed on both sides, with relubrication facility (INA)

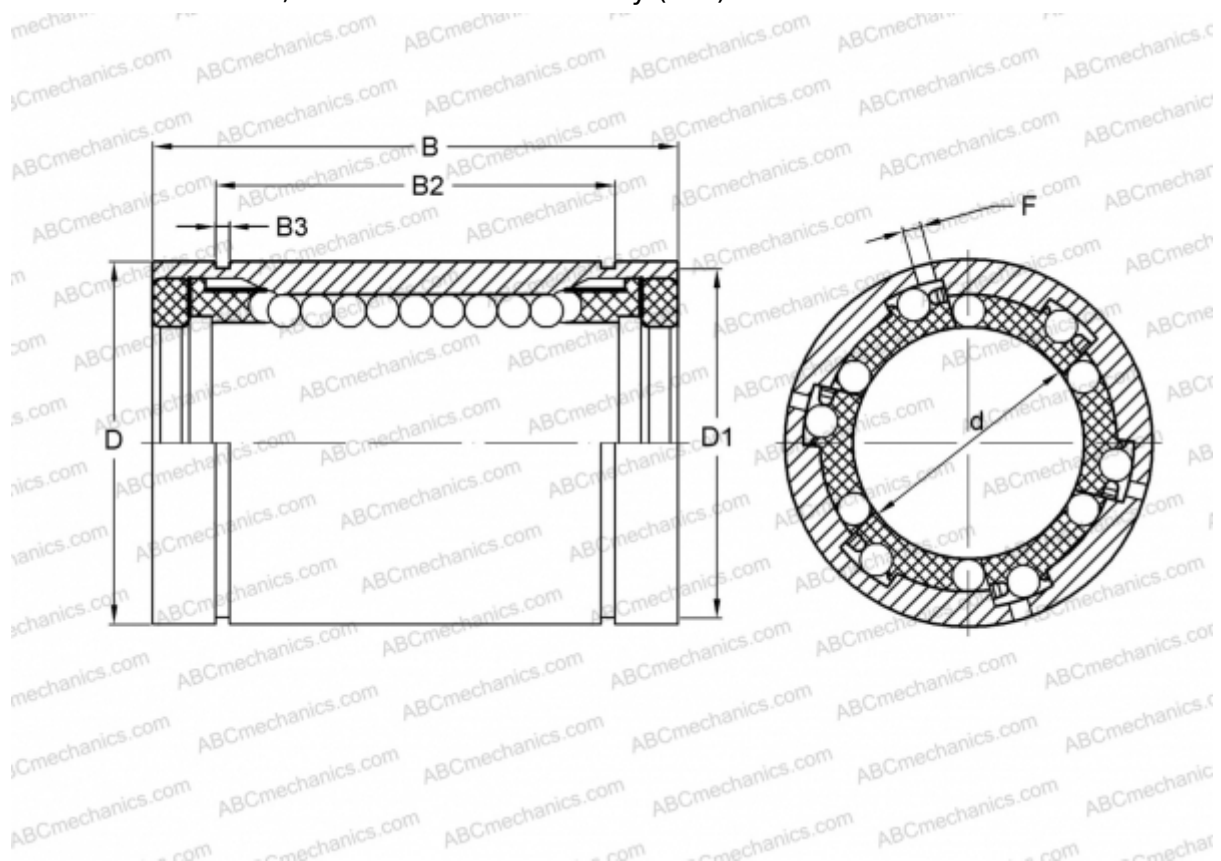

Technical specification

DIMENSIONS, MM

d	25,000
D	40,000
B	58,000
D1	37,500
B2	43,700
B3	1,850
F	2.5

WEIGHT, KG 0,190

MANUFACTURER [INA](#)