

KB50-PP-AS INA

Linear bushing

TYPE: Shaft guidance systems, Linear bushing, Standard, Close type, Type KB..PP-AS, machined range, sealed on both sides, with relubrication facility (INA)

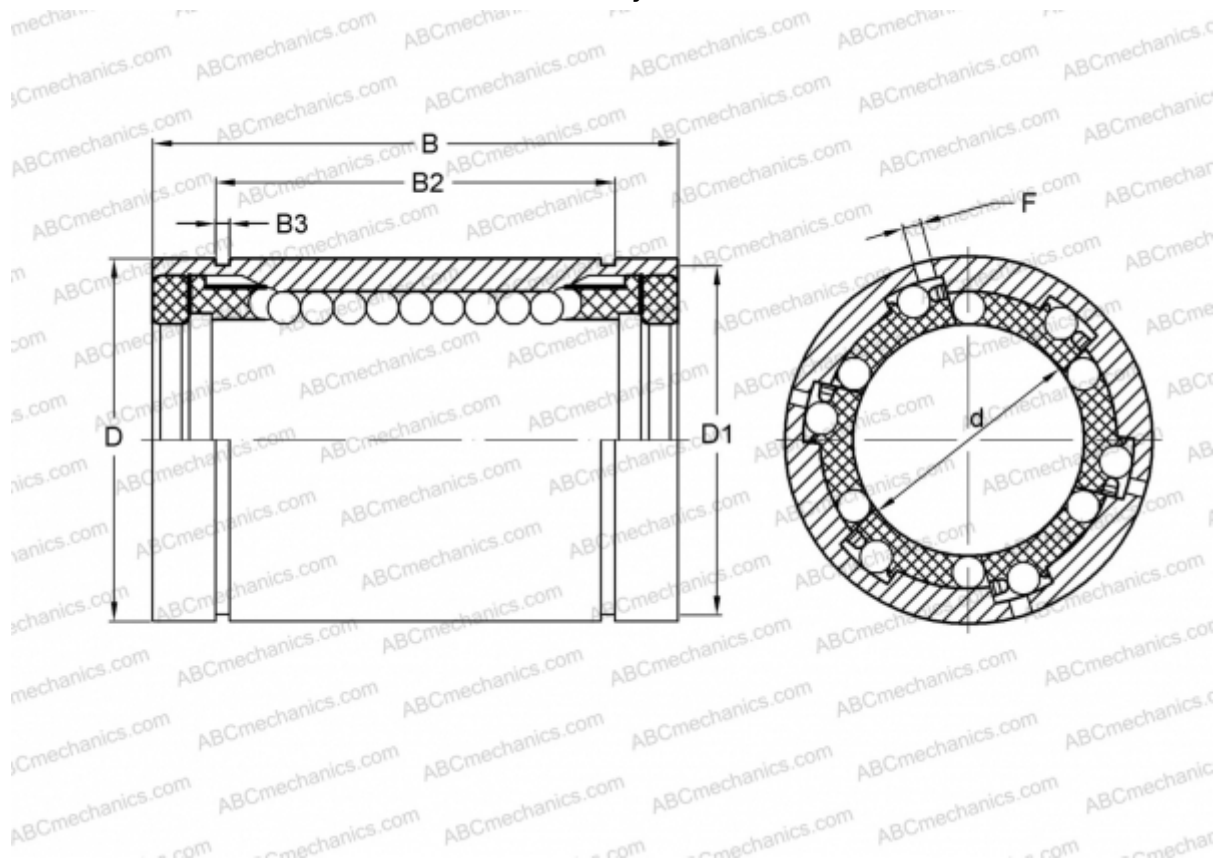

Technical specification

DIMENSIONS, MM

d	50,000
D	75,000
B	100,000
D1	72,000
B2	77,300
B3	2,650
F	4

WEIGHT, KG 1,000

MANUFACTURER [INA](#)