

KBZ04-PP INA

Linear bushing

TYPE: Shaft guidance systems, Linear bushing, Standard, Close type, Type KBZ..PP, machined range, sealed on both sides, inch size (INA)

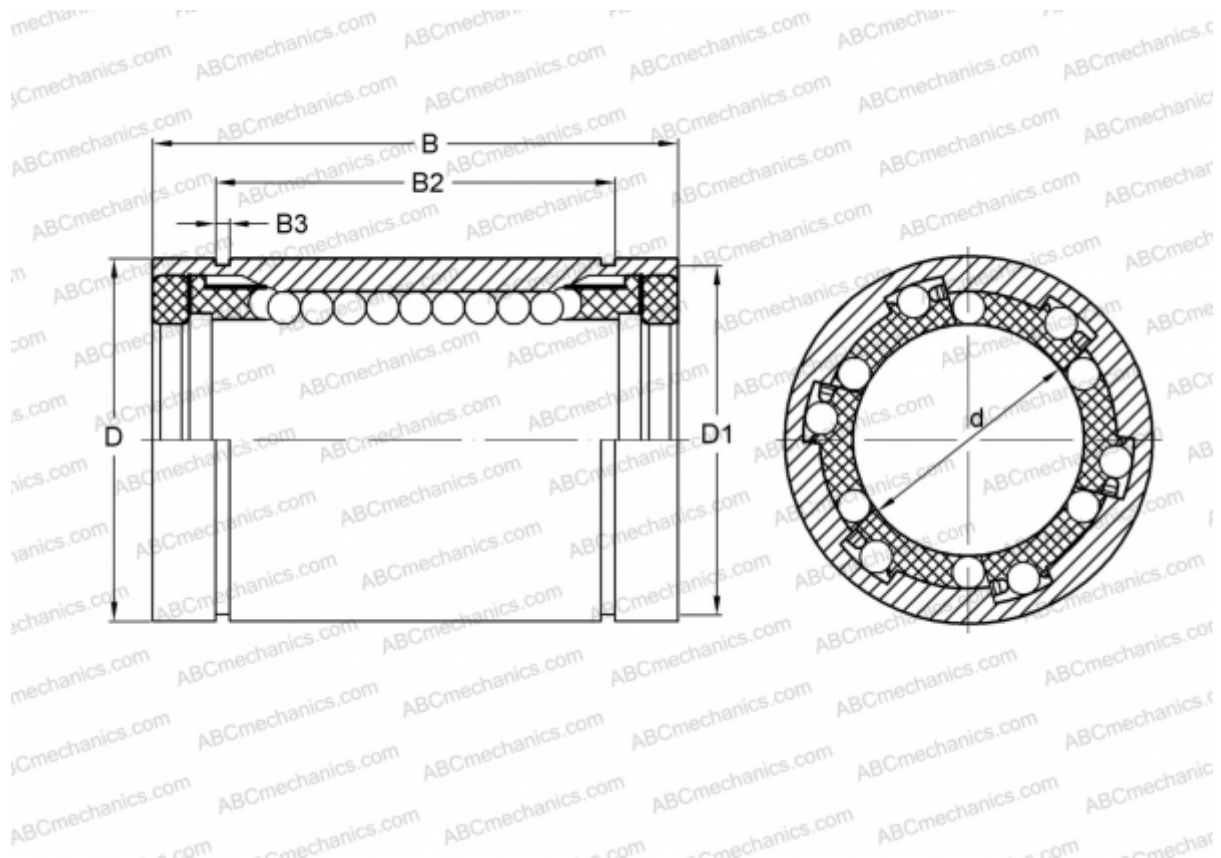

Technical specification

DIMENSIONS, MM

d	6,350
D	12,700
B	19,050
D1	11,913
B2	12,979
B3	0,991

WEIGHT, KG 0,009

MANUFACTURER [INA](#)