

KBZ06-PP INA

Linear bushing

TYPE: Shaft guidance systems, Linear bushing, Standard, Close type, Type KBZ..PP, machined range, sealed on both sides, inch size (INA)

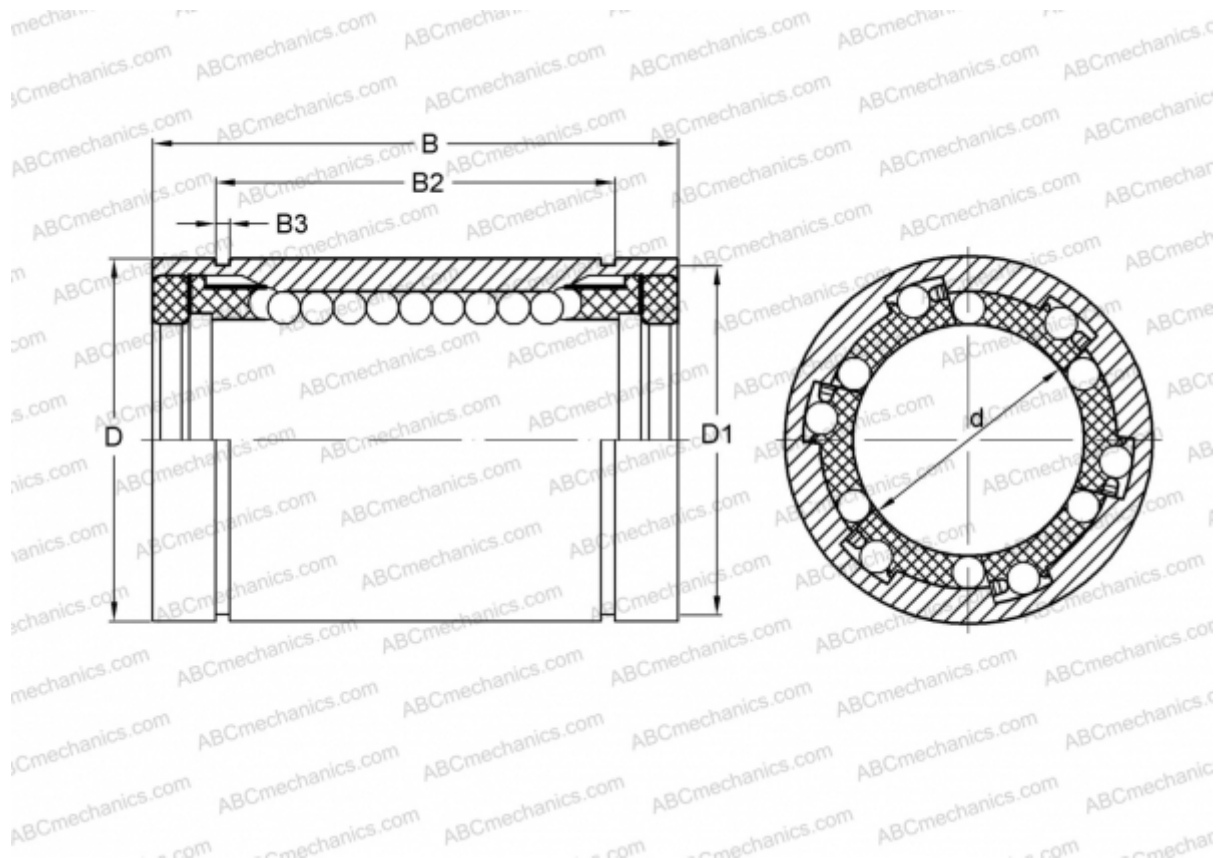

Technical specification

DIMENSIONS, MM

d	9,525
D	15,875
B	22,225
D1	14,935
B2	16,154
B3	0,991

WEIGHT, KG 0,014

MANUFACTURER [INA](#)