

## KBZ08-PP INA

Linear bushing

TYPE: Shaft guidance systems, Linear bushing, Standard, Close type, Type KBZ..PP, machined range, sealed on both sides, inch size (INA)

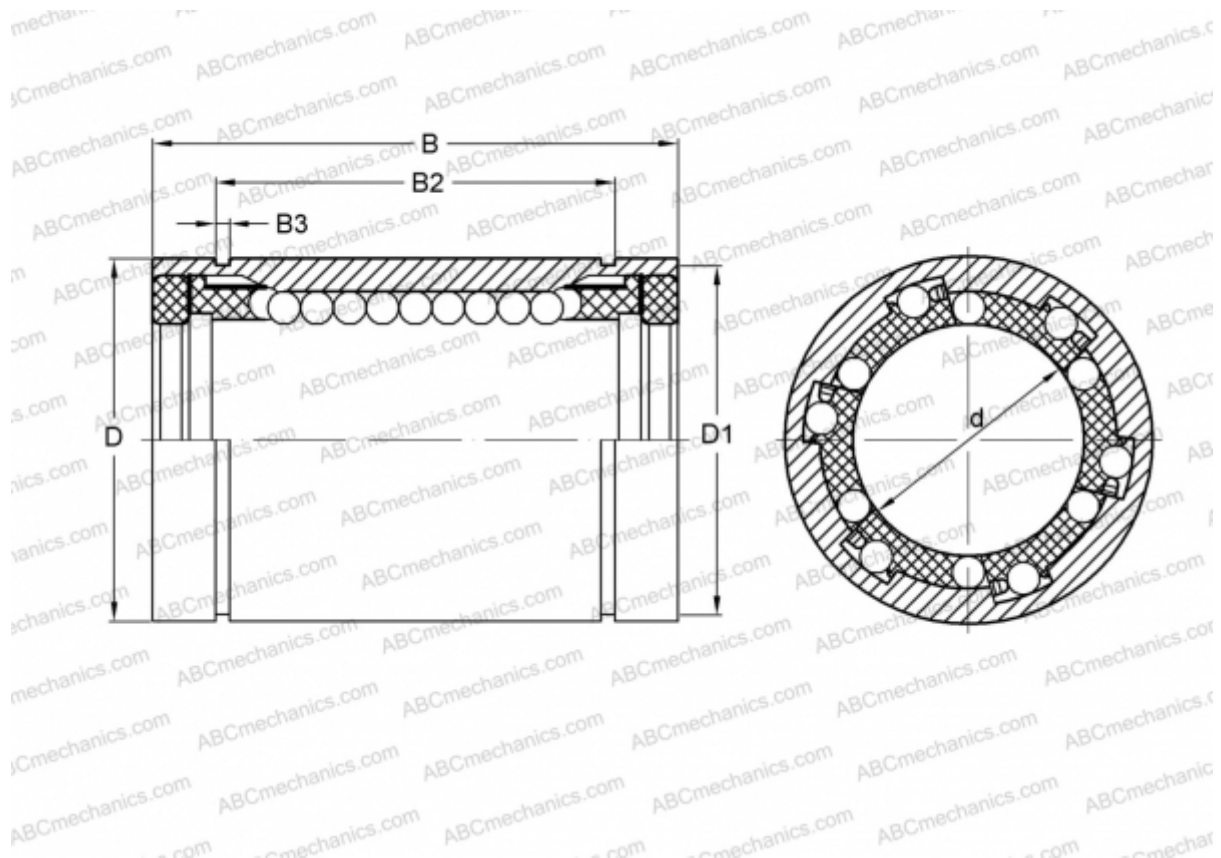

### Technical specification

#### DIMENSIONS, MM

d	12,700
D	22,225
B	31,750
D1	20,853
B2	24,460
B3	1,168

**WEIGHT, KG** 0,036

**MANUFACTURER** [INA](#)