

## KBZ10-PP INA

Linear bushing

TYPE: Shaft guidance systems, Linear bushing, Standard, Close type, Type KBZ..PP, machined range, sealed on both sides, inch size (INA)

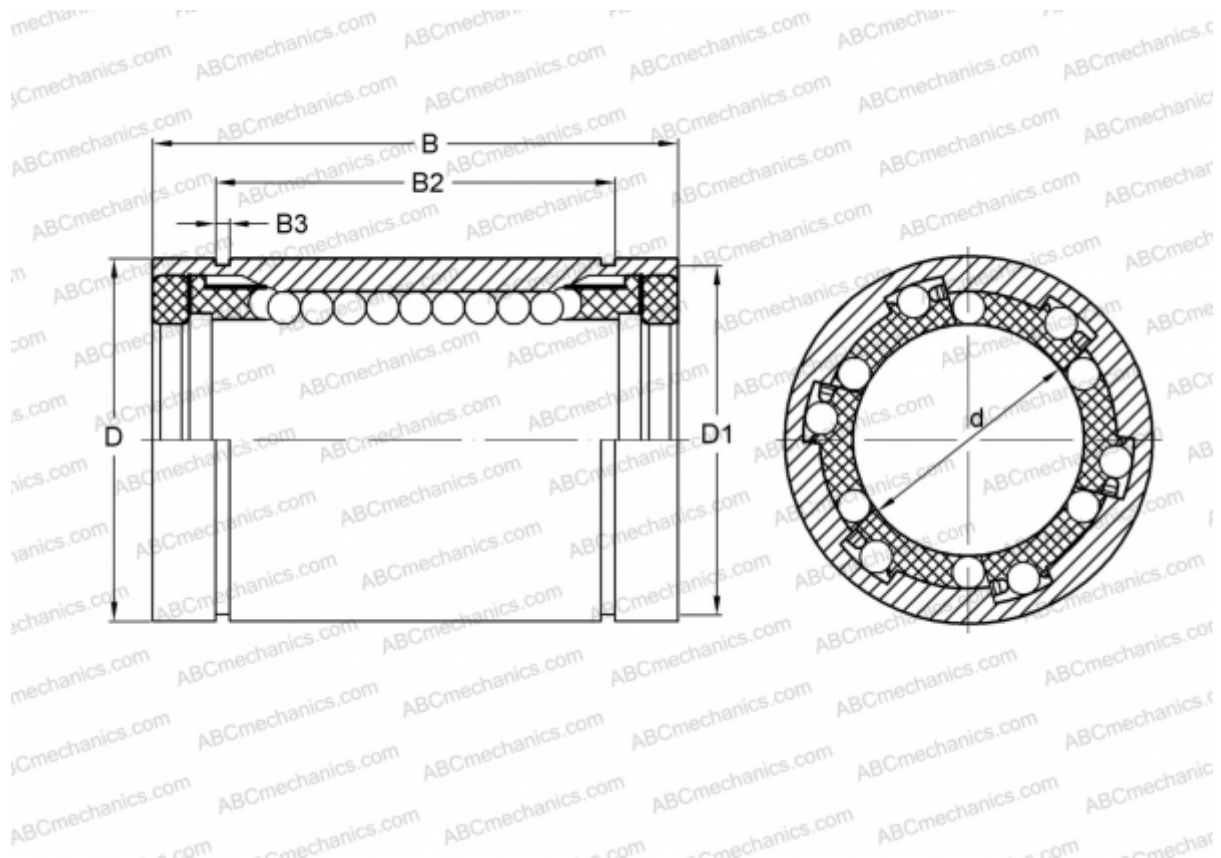

### Technical specification

#### DIMENSIONS, MM

d	15,875
D	28,575
B	38,100
D1	26,899
B2	28,042
B3	1,422

**WEIGHT, KG** 0,077

**MANUFACTURER** [INA](#)