

## KBZ24-PP INA

Linear bushing

TYPE: Shaft guidance systems, Linear bushing, Standard, Close type, Type KBZ..PP, machined range, sealed on both sides, inch size (INA)

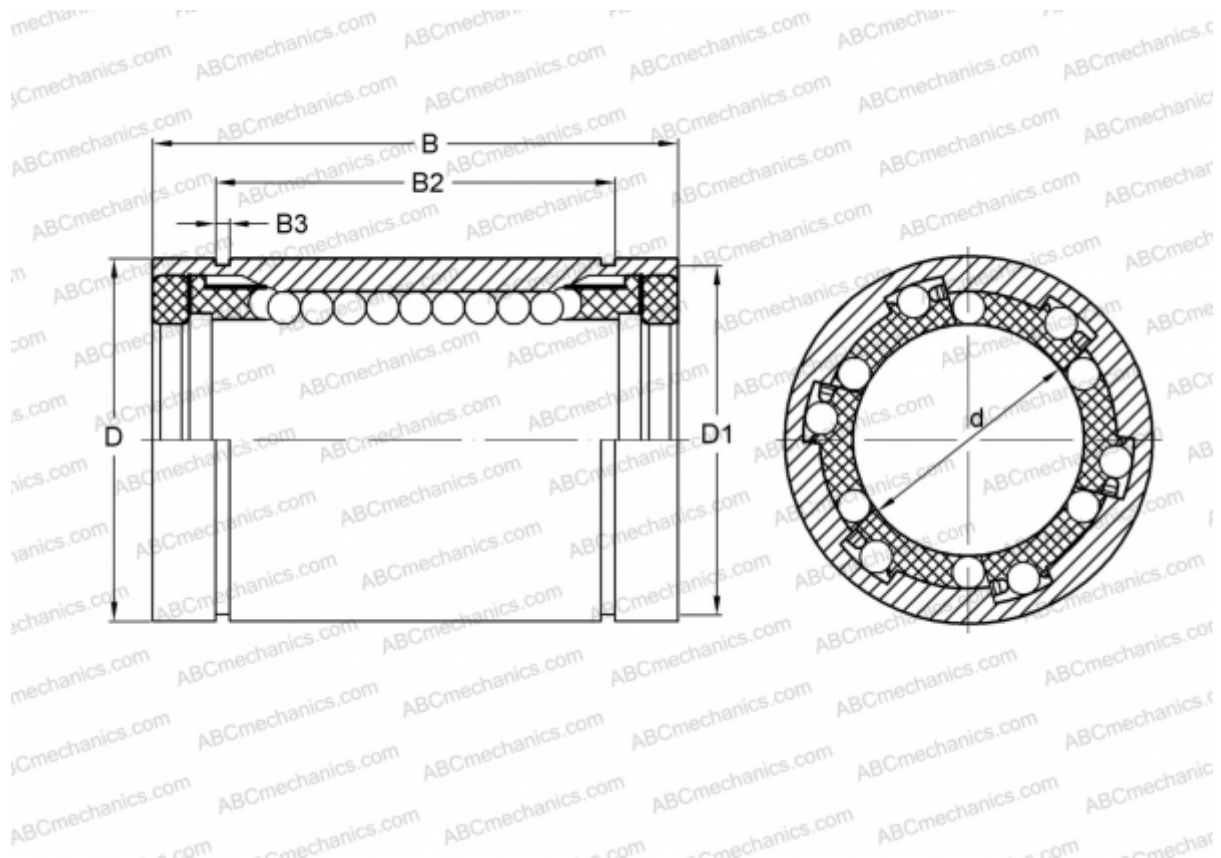

### Technical specification

#### DIMENSIONS, MM

d	38,100
D	60,325
B	76,200
D1	56,871
B2	61,265
B3	2,184

**WEIGHT, KG** 0,671

**MANUFACTURER** [INA](#)