

KBO30-PP-AS INA

Linear bushing

TYPE: Shaft guidance systems, Linear bushing, Standard, Open type for support rail, Type KBO..PP-AS, machined range, sealed on both sides, with relubrication facility (INA)

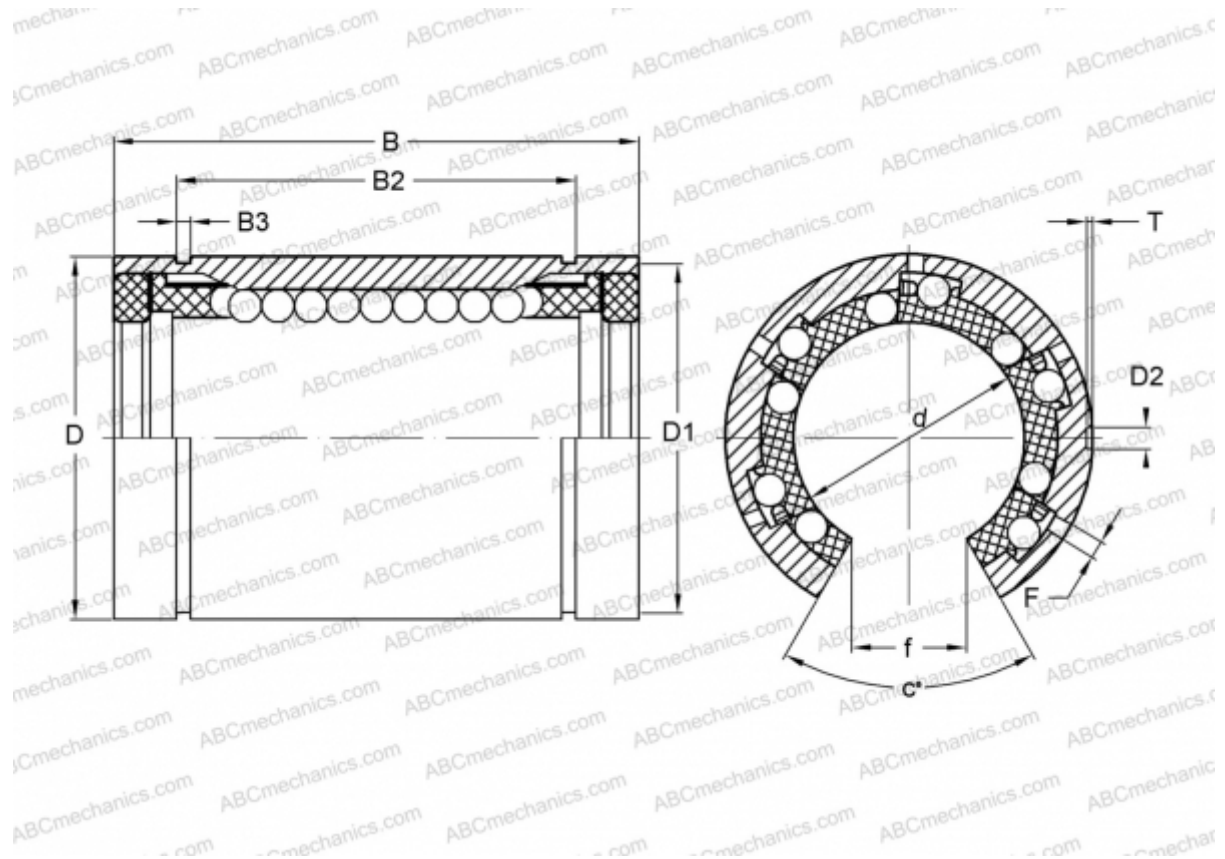

Technical specification

DIMENSIONS, MM

d	30,000
D	47,000
B	68,000
D1	44,500
D2	3,000
B2	51,700
B3	1,850
T	1,500
f	13,600
c	54
F	2.5

WEIGHT, KG 0,240

MANUFACTURER [INA](http://www.ina.com)