

KBZ08-OP-PP INA

Linear bushing

TYPE: Shaft guidance systems, Linear bushing, Standard, Open type for support rail, Type KBZ..OP-PP, machined range, sealed on both sides, inch size (INA)

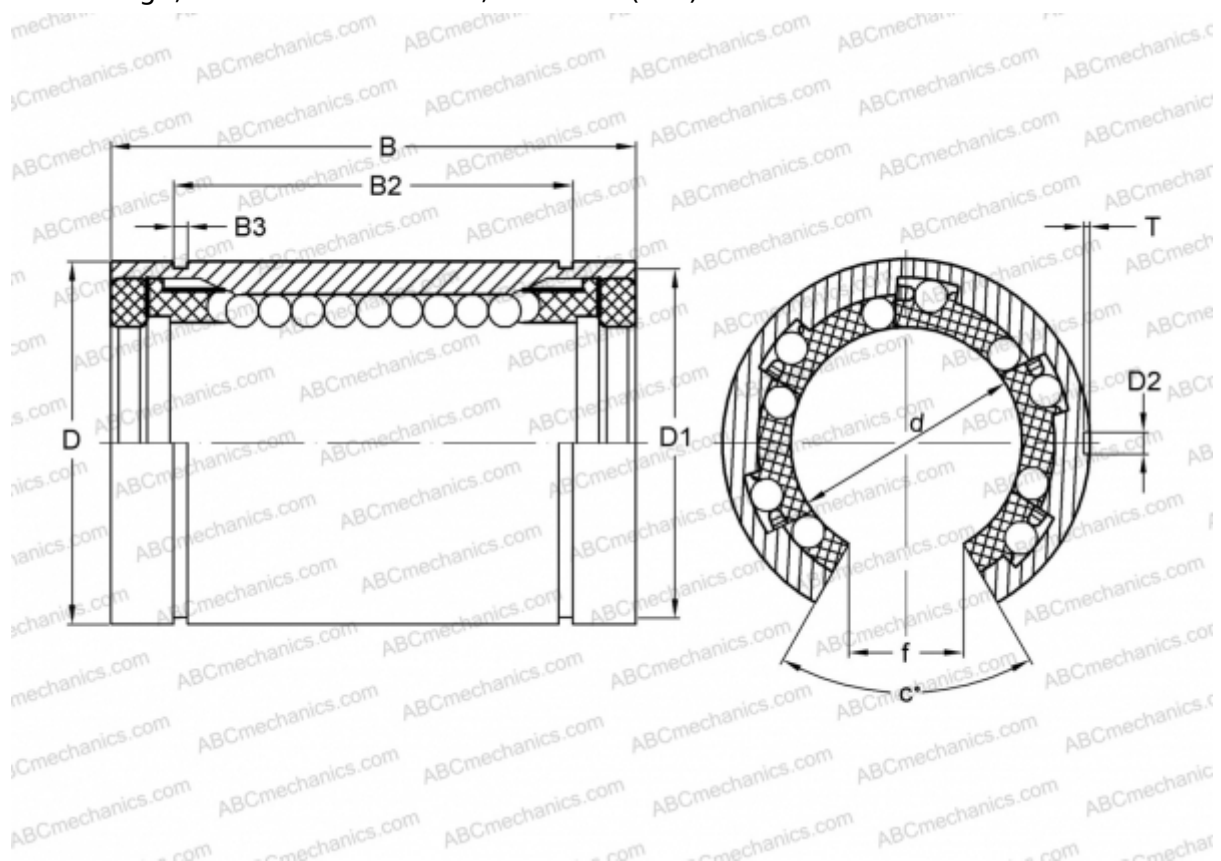

Technical specification

DIMENSIONS, MM

d	12,700
D	22,225
B	31,750
D1	20,853
B2	24,460
B3	1,168
f	7,950
c	80

WEIGHT, KG 0,027

MANUFACTURER [INA](http://www.ina.com)