

KBZ10-OP-PP INA

Linear bushing

TYPE: Shaft guidance systems, Linear bushing, Standard, Open type for support rail, Type KBZ..OP-PP, machined range, sealed on both sides, inch size (INA)

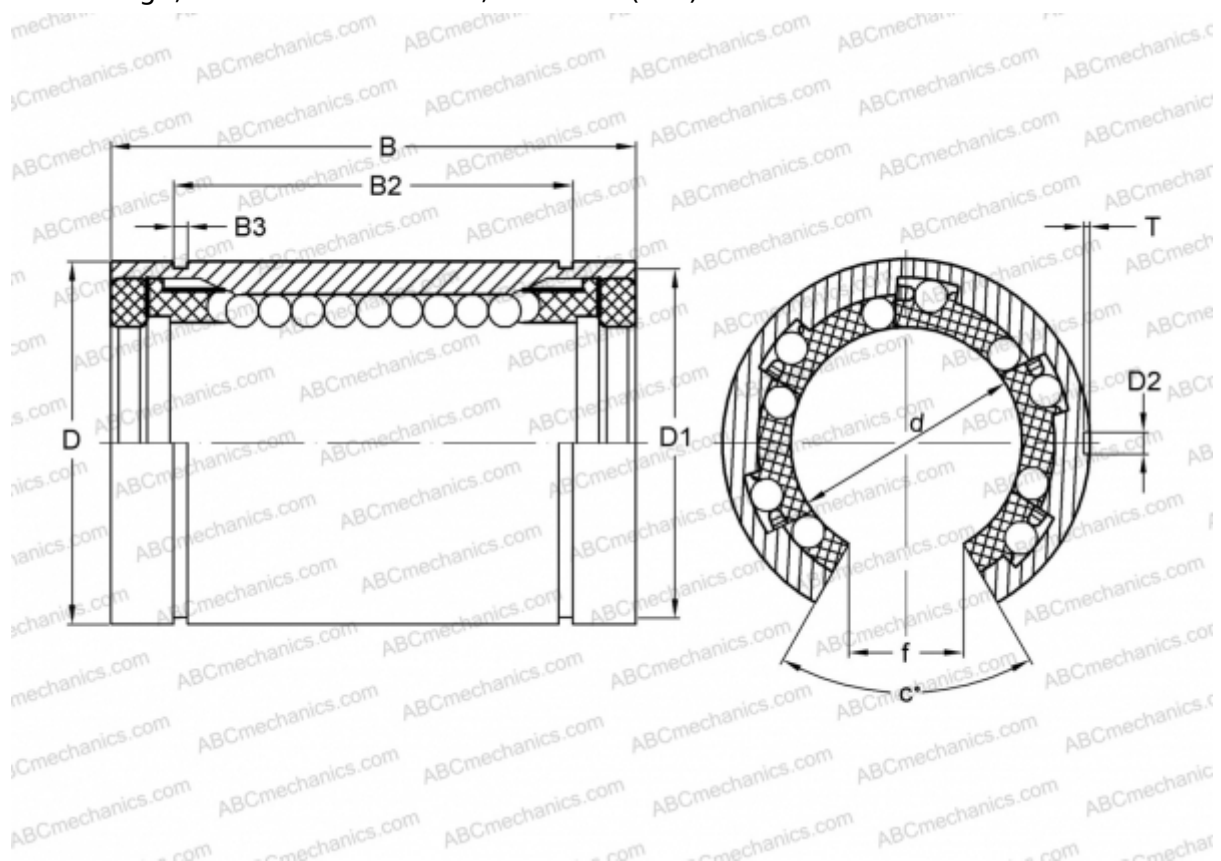

Technical specification

DIMENSIONS, MM

d	15,875
D	28,575
B	38,100
D1	26,899
B2	28,042
B3	1,422
f	9,525
c	80

WEIGHT, KG 0,059

MANUFACTURER [INA](http://www.ina.com)