

KBZ24-OP-PP INA

Linear bushing

TYPE: Shaft guidance systems, Linear bushing, Standard, Open type for support rail, Type KBZ..OP-PP, machined range, sealed on both sides, inch size (INA)

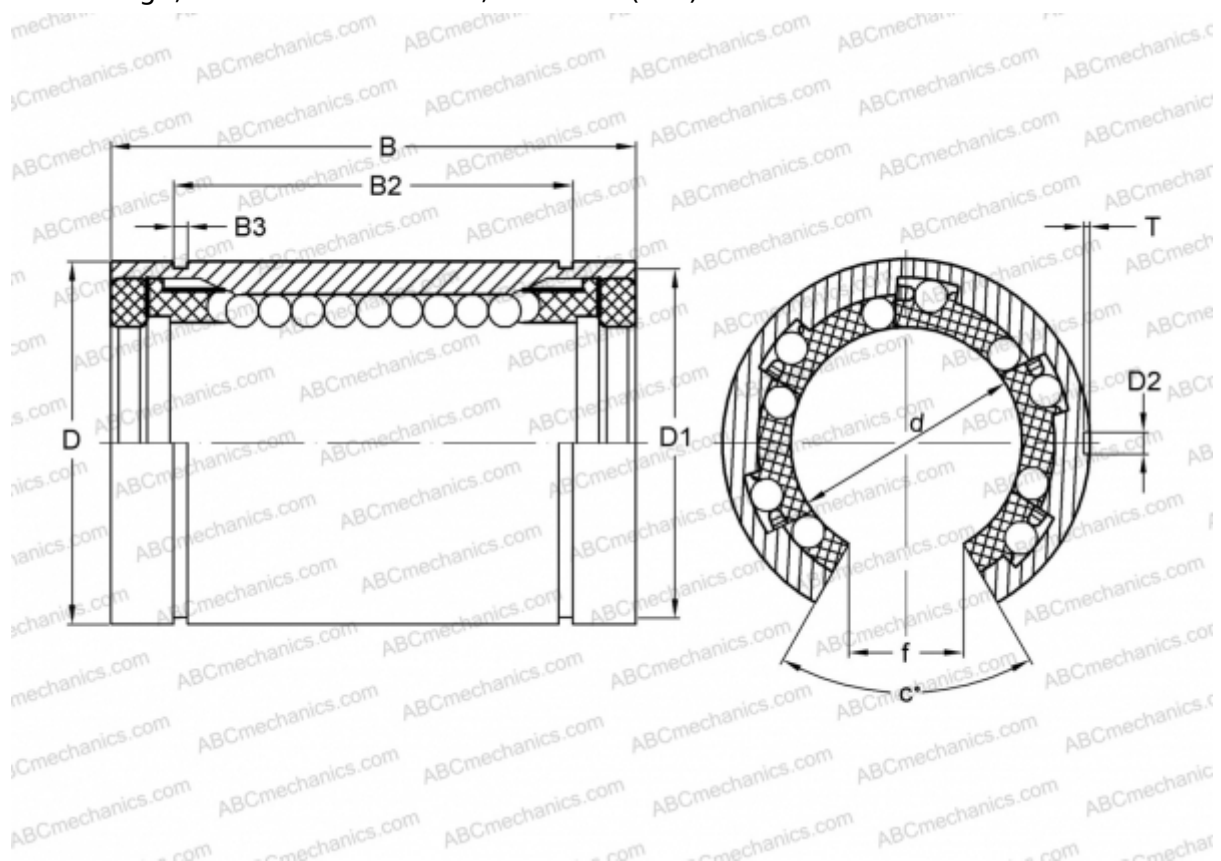

Technical specification

DIMENSIONS, MM

d	38,100
D	60,325
B	76,200
D1	56,871
B2	61,265
B3	2,184
f	19,050
c	50

WEIGHT, KG 0,572

MANUFACTURER [INA](http://www.ina.com)