

CR 3101 CR

Radial shaft seals

TYPE: Radial shaft seals, Metal case, With spring-loaded sealing lip, Type CRWA5, material NBR (SKF)

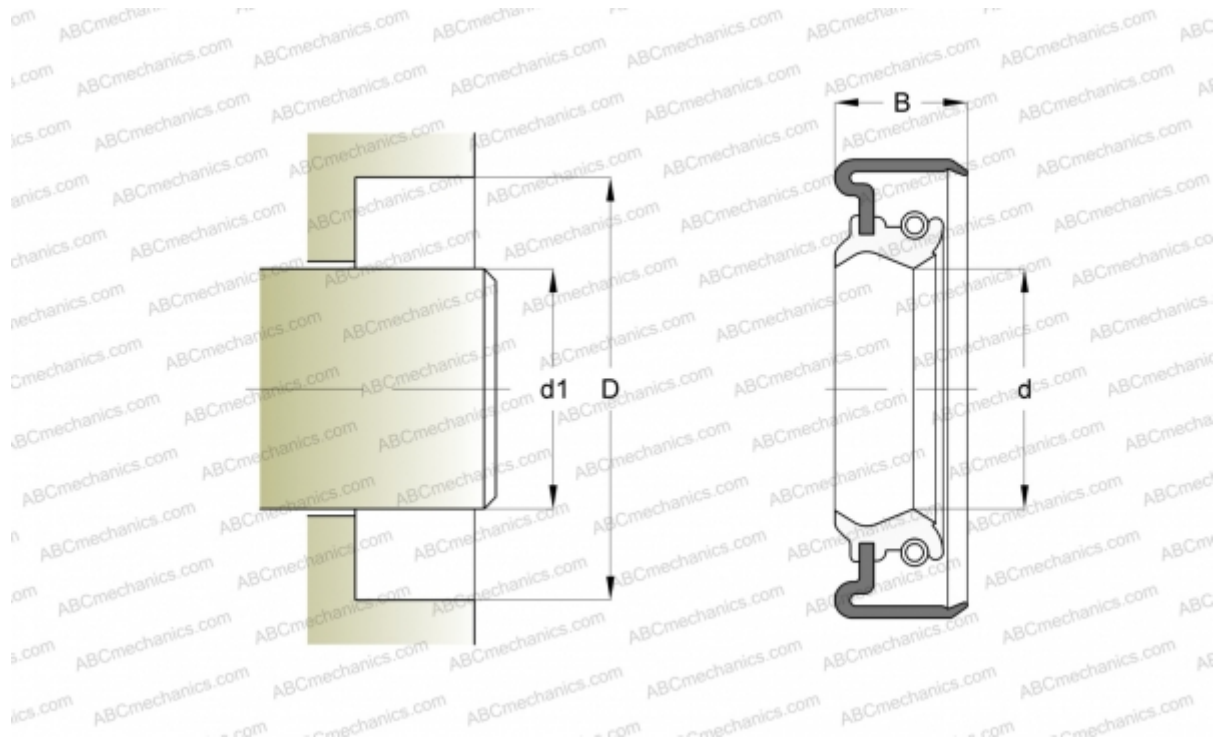

Technical specification

DIMENSIONS, MM

d1	7,950
d	7,950
D	19,025
B	6,350

MANUFACTURER [CR](#)

INTERCHANGE

SKF	3101
-----	----------------------

CALCULATION DATA

Operating temperature min	-40 °C
Operating temperature max	100 °C
Permissible operating temperature, short periods max	120 °C
Pressure differential max	0,630 Mpa
Maximum shaft surface speed	10,000 m/s