

## CR 3171 CR

Radial shaft seals

TYPE: Radial shaft seals, Metal case, With spring-loaded sealing lip, Type CRWA5, material NBR (SKF)

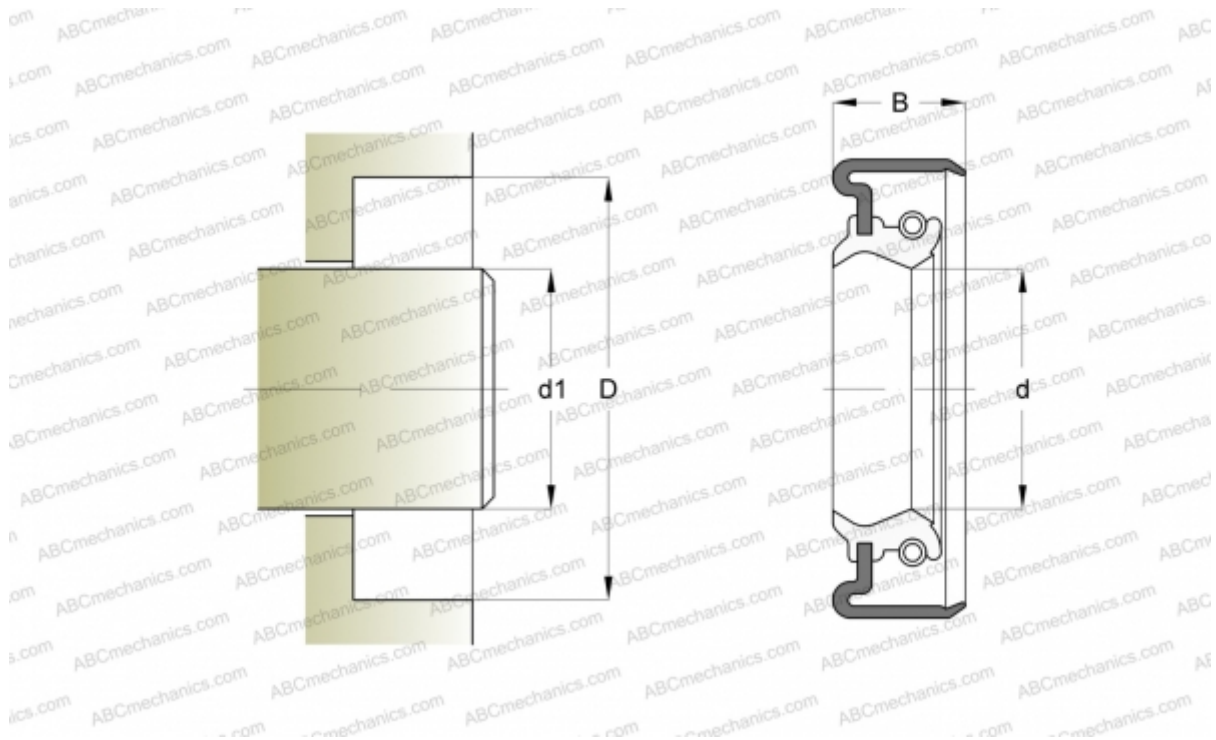

### Technical specification

#### DIMENSIONS, MM

$d_1$	7,950
$d$	7,950
$D$	25,375
$B$	7,950

**MANUFACTURER** [CR](#)

#### INTERCHANGE

SKF [3171](#)

#### CALCULATION DATA

Operating temperature min	-40 °C
Operating temperature max	100 °C
Permissible operating temperature, short periods max	120 °C
Pressure differential max	0,630 Mpa
Maximum shaft surface speed	10,000 m/s