

## CR 7449 CR

Radial shaft seals

TYPE: Radial shaft seals, Metal case, With spring-loaded sealing lip, Type CRWA5, material NBR (SKF)

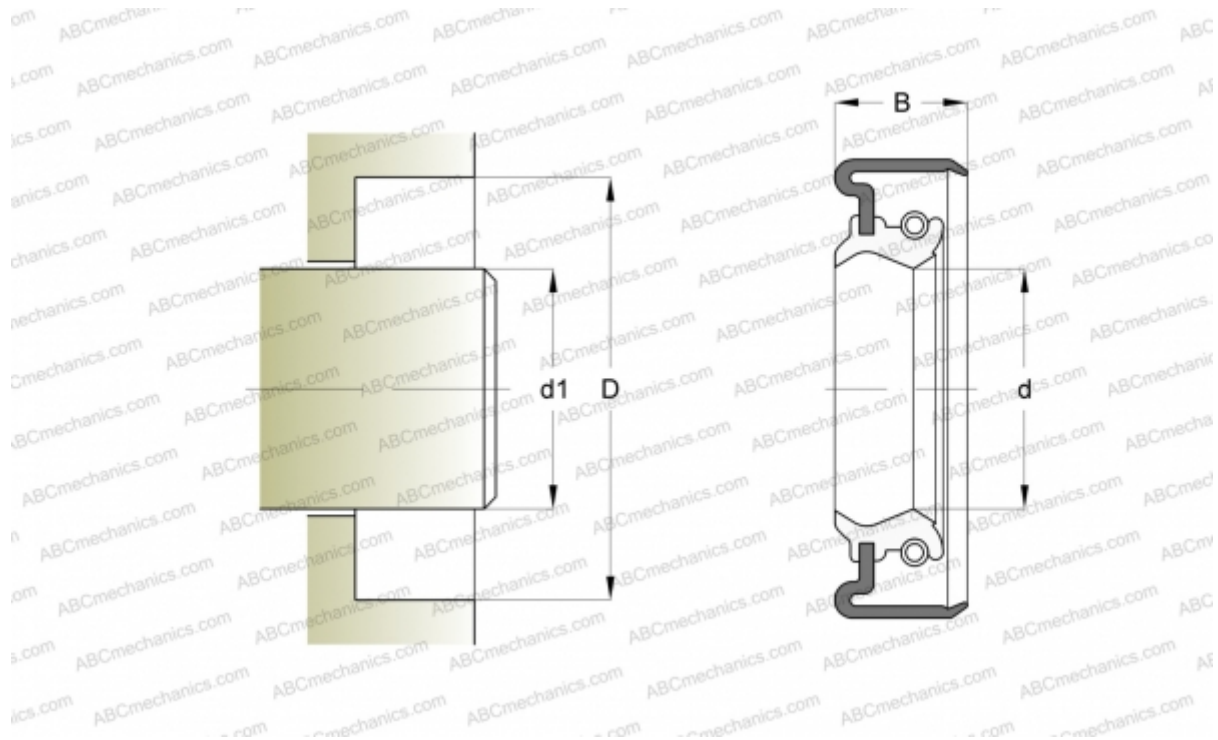

### Technical specification

#### DIMENSIONS, MM

$d_1$	19,050
$d$	19,050
$D$	31,750
$B$	9,525

**MANUFACTURER** [CR](#)

#### INTERCHANGE

SKF	<a href="#">7449</a>
-----	----------------------

#### CALCULATION DATA

Operating temperature min	-40 °C
Operating temperature max	100 °C
Permissible operating temperature, short periods max	120 °C
Pressure differential max	0,630 Mpa
Maximum shaft surface speed	10,000 m/s