

## 9814 SKF

Radial shaft seals

TYPE: Radial shaft seals, Metal case, With spring-loaded sealing lip, Type CRWA5, material NBR (SKF)

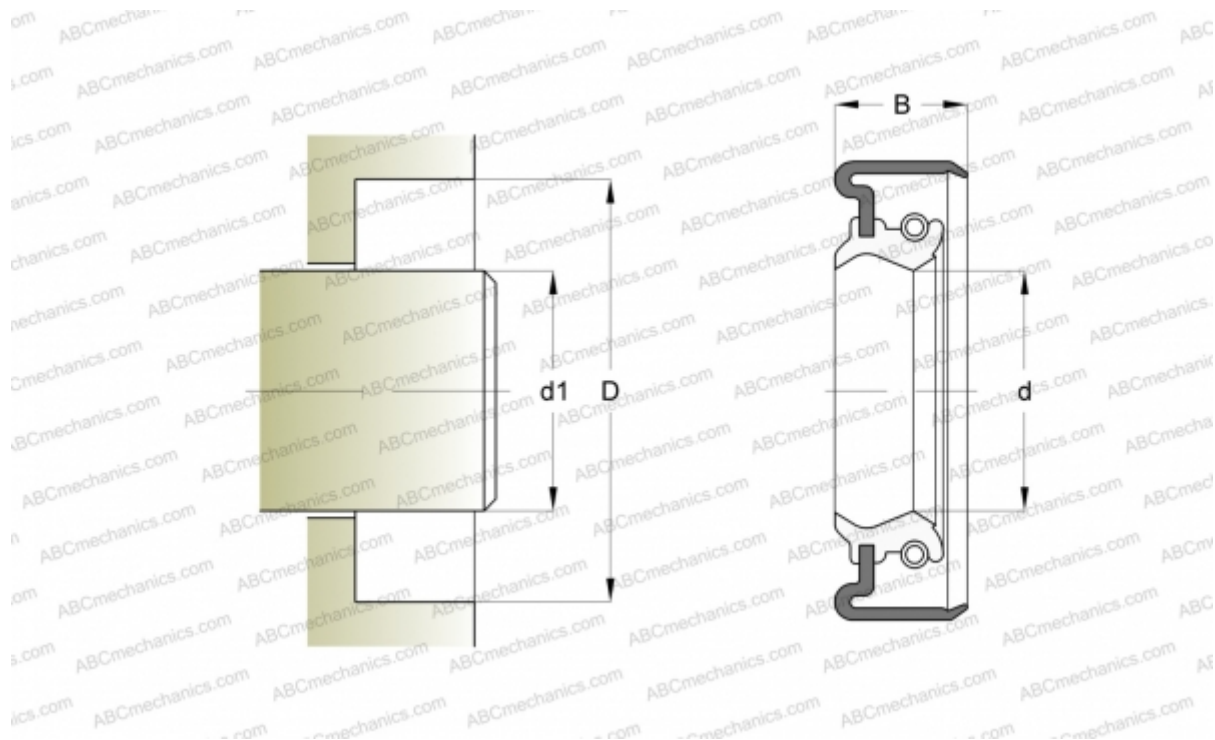

### Technical specification

#### DIMENSIONS, MM

d1	25,400
d	25,400
D	34,925
B	6,350

**MANUFACTURER** [SKF](#)

#### INTERCHANGE

CR [CR 9814](#)

#### CALCULATION DATA

Operating temperature min	-40 °C
Operating temperature max	100 °C
Permissible operating temperature, short periods max	120 °C
Pressure differential max	0,630 Mpa
Maximum shaft surface speed	10,000 m/s