

24892 SKF

Radial shaft seals

TYPE: Radial shaft seals, Metal case, With spring-loaded sealing lip, Type CRWA5, material NBR (SKF)

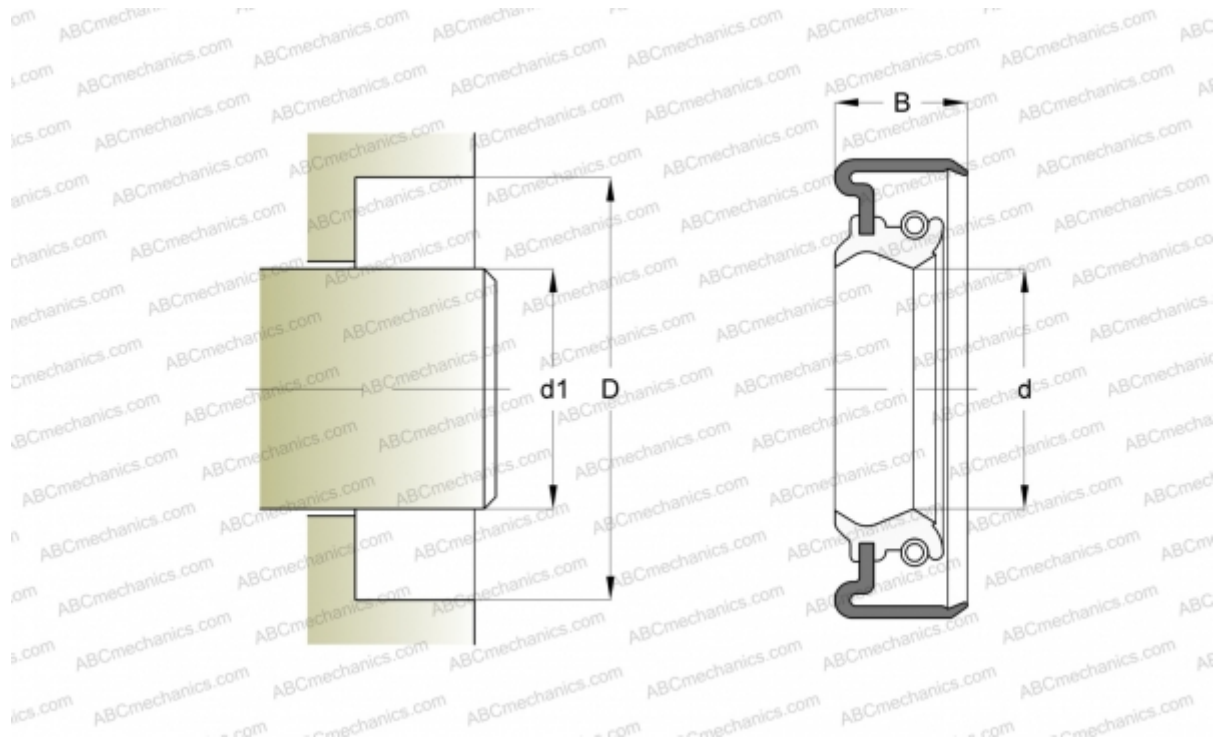

Technical specification

DIMENSIONS, MM

d1	63,500
d	63,500
D	82,575
B	8,890

MANUFACTURER [SKF](#)

INTERCHANGE

CR [CR 24892](#)

CALCULATION DATA

Operating temperature min	-40 °C
Operating temperature max	100 °C
Permissible operating temperature, short periods max	120 °C
Pressure differential max	0,630 Mpa
Maximum shaft surface speed	10,000 m/s