

CR 9858 CR

Radial shaft seals

TYPE: Radial shaft seals, Metal case, With spring-loaded sealing lip, Type CRWA5, material FPM/FKM (SKF)

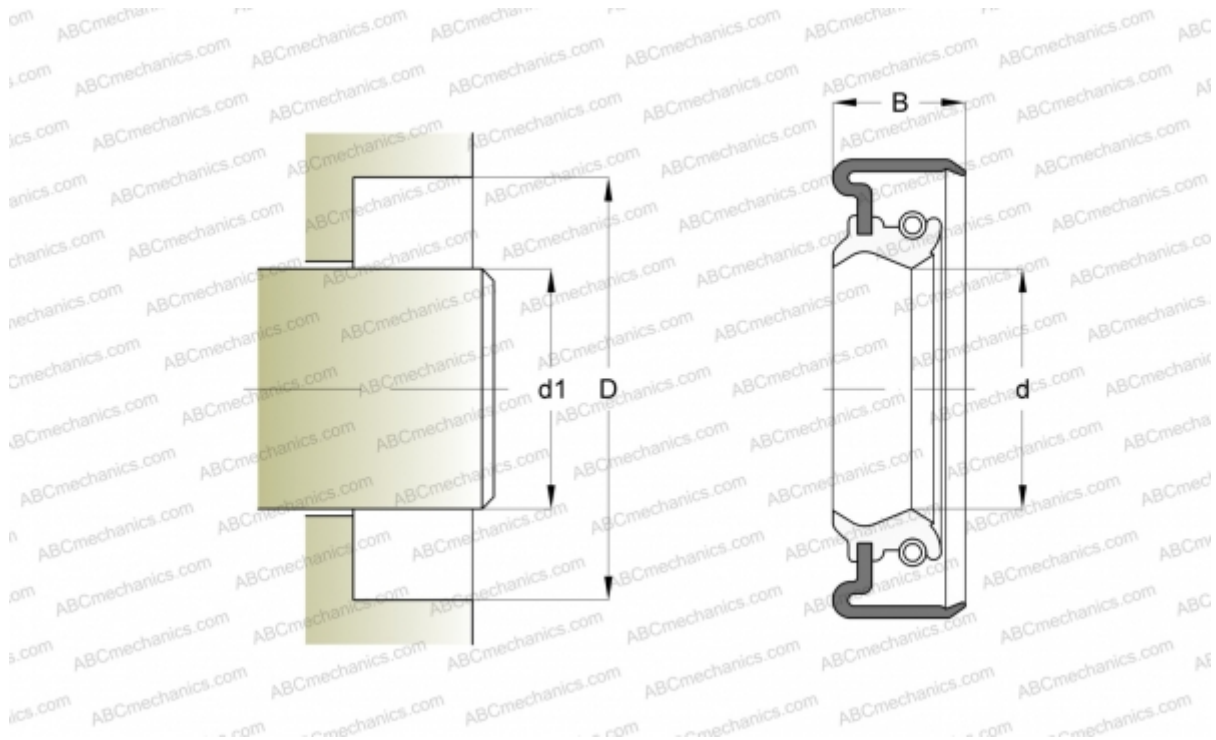

Technical specification

DIMENSIONS, MM

d_1	25,400
d	25,400
D	38,075
B	6,350

MANUFACTURER [CR](#)

INTERCHANGE

SKF [9858](#)

CALCULATION DATA

Operating temperature min	-40 °C
Operating temperature max	200 °C
Permissible operating temperature, short periods max	220 °C
Pressure differential max	0,630 Mpa
Maximum shaft surface speed	10,000 m/s