

12339 SKF

Radial shaft seals

TYPE: Radial shaft seals, Metal case, With spring-loaded sealing lip, Type CRWA5, material FPM/FKM (SKF)

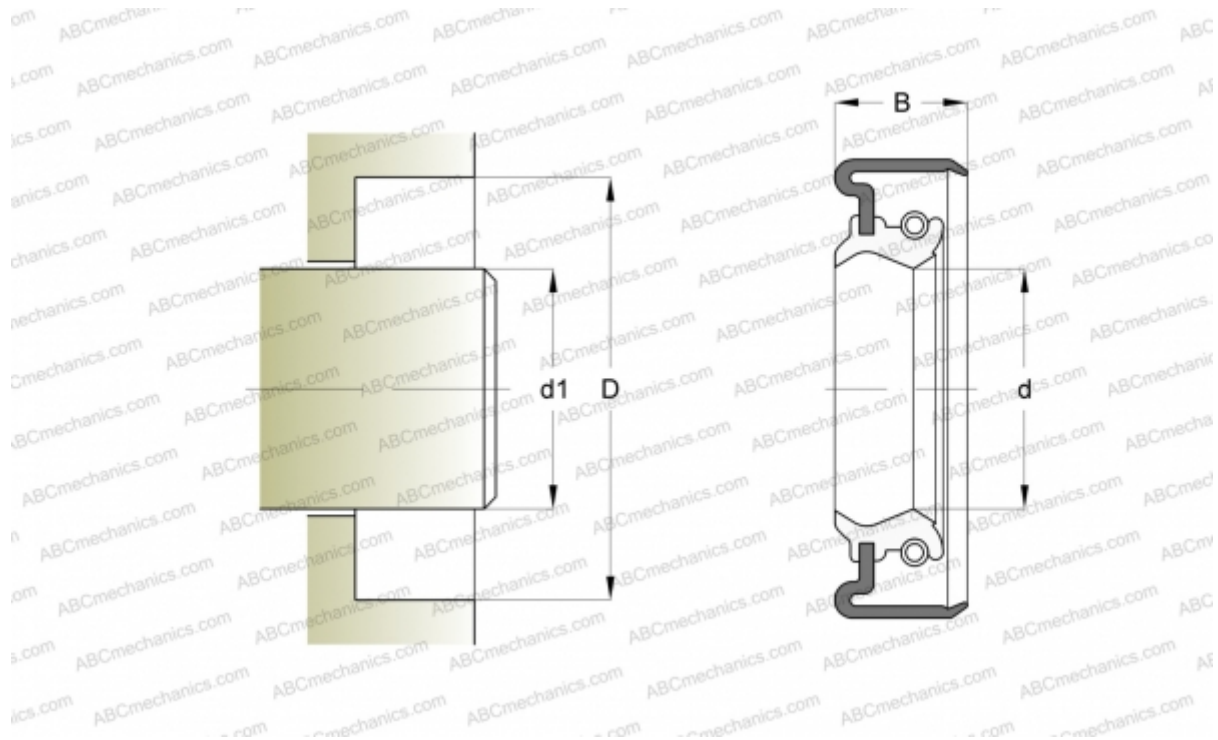

Technical specification

DIMENSIONS, MM

d1	31,750
d	31,750
D	44,450
B	6,350

MANUFACTURER [SKF](#)

INTERCHANGE

CR [CR 12339](#)

CALCULATION DATA

Operating temperature min	-40 °C
Operating temperature max	200 °C
Permissible operating temperature, short periods max	220 °C
Pressure differential max	0,630 Mpa
Maximum shaft surface speed	10,000 m/s