

## CR 14868 CR

Radial shaft seals

TYPE: Radial shaft seals, Metal case, With spring-loaded sealing lip, Type CRWA5, material FPM/FKM (SKF)

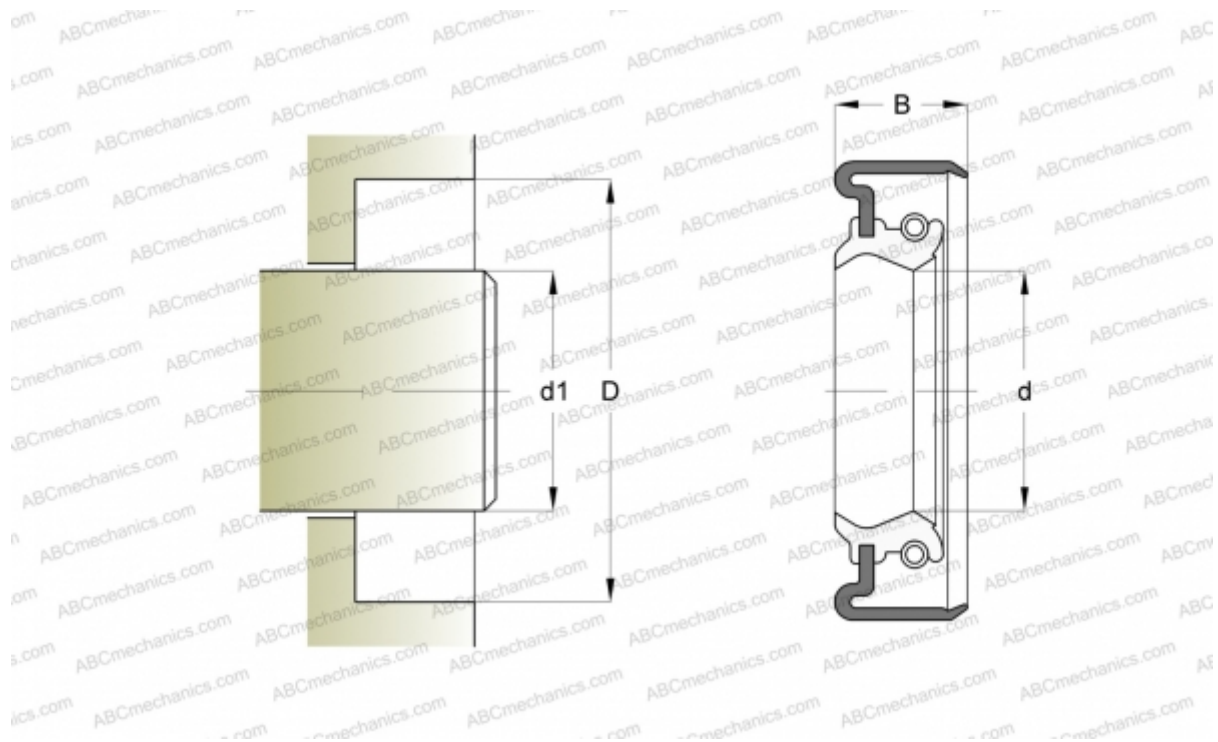

### Technical specification

#### DIMENSIONS, MM

$d_1$	38,100
$d$	38,100
$D$	52,426
$B$	9,525

**MANUFACTURER** [CR](#)

#### INTERCHANGE

SKF [14868](#)

#### CALCULATION DATA

Operating temperature min	-40 °C
Operating temperature max	200 °C
Permissible operating temperature, short periods max	220 °C
Pressure differential max	0,630 Mpa
Maximum shaft surface speed	10,000 m/s