

3189981 SKF

Radial shaft seals

TYPE: Radial shaft seals, Metal case, With spring-loaded sealing lip, Type HDSF2, material FPM/FKM, PTFE (SKF)

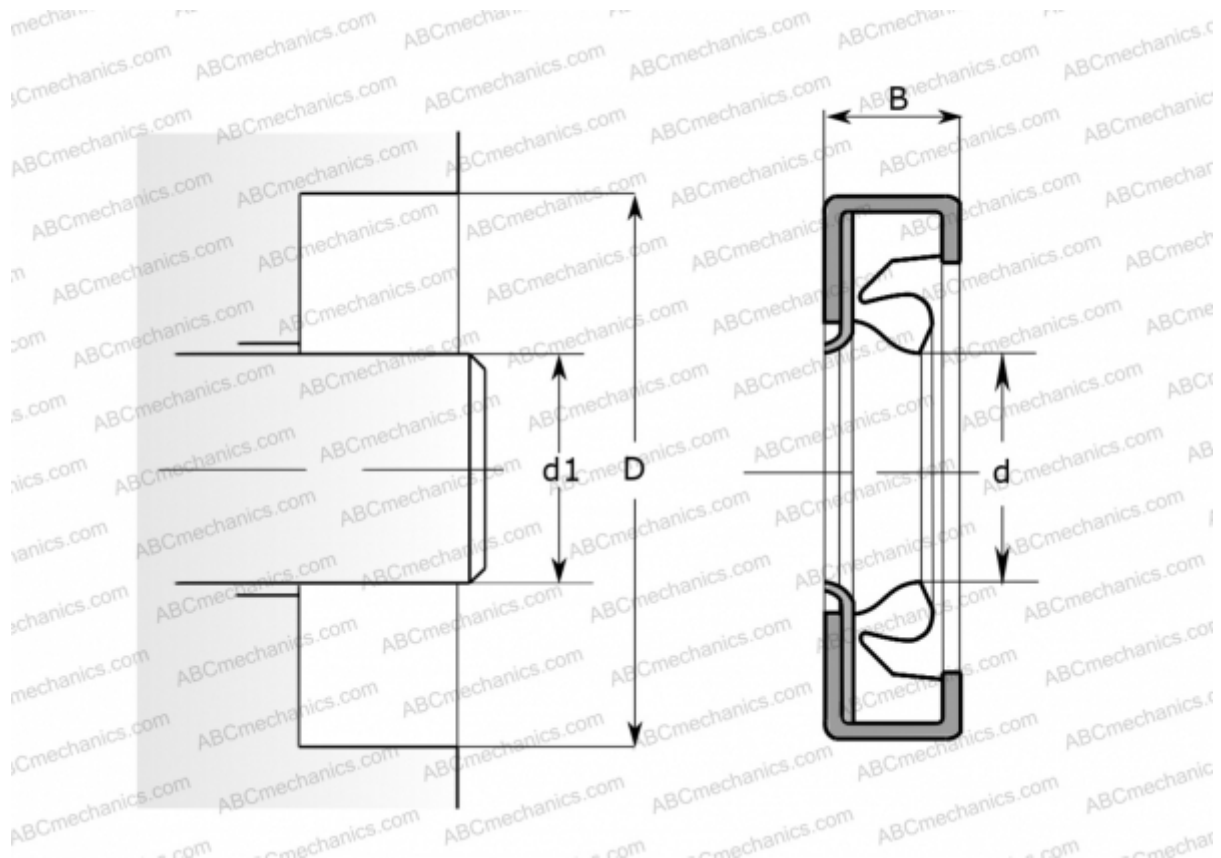

Technical specification

DIMENSIONS, MM

d_1	810,010
d	810,010
D	873,990
B	23,390

MANUFACTURER

[SKF](#)

CALCULATION DATA

Maximum shaft surface speed	0,001 m/s
-----------------------------	-----------