

760x800x20 HDSF7 HT SKF

Radial shaft seals

TYPE: Radial shaft seals, Metal case, With spring-loaded sealing lip, Type HDSF7, material H-NBR/NEM, PTFE (SKF)

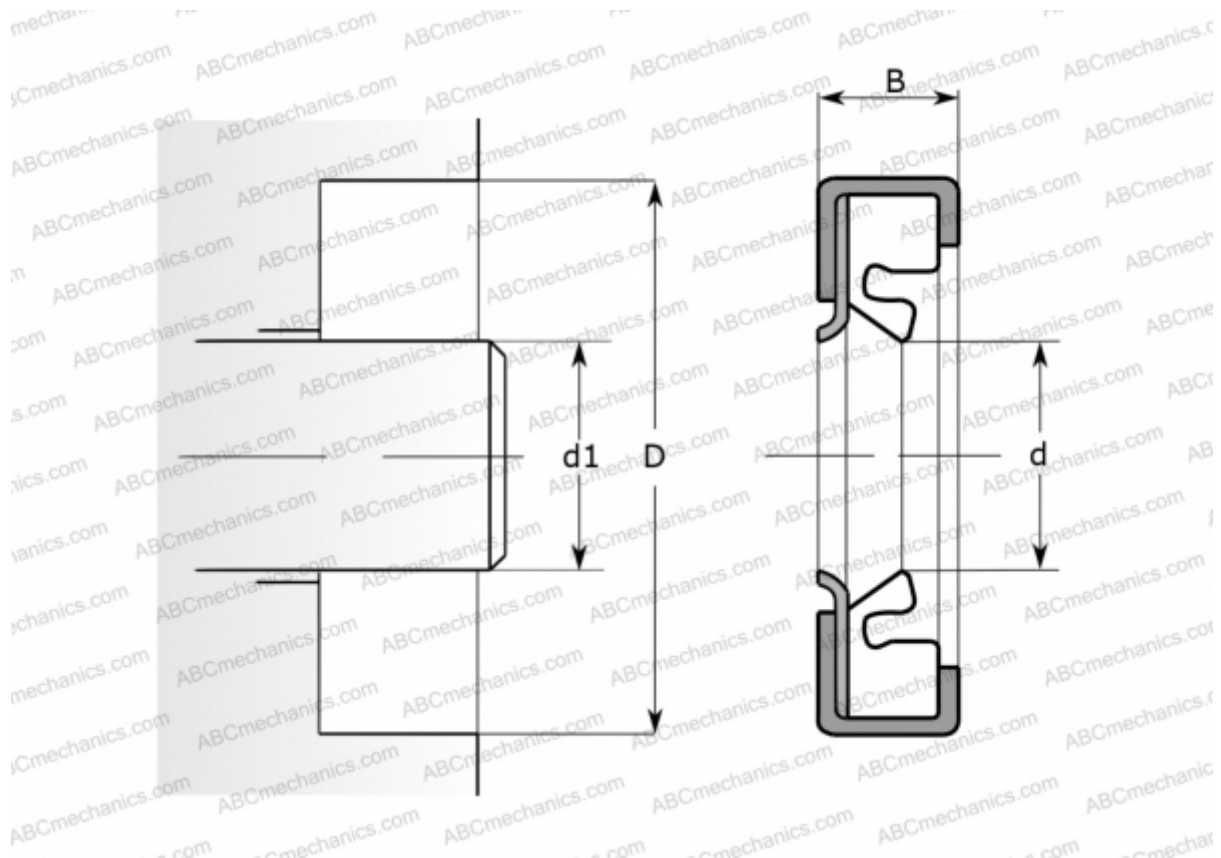

Technical specification

DIMENSIONS, MM

d_1	760,000
d	760,000
D	800,000
B	20,000

MANUFACTURER [SKF](#)

CALCULATION DATA

Maximum shaft surface speed	0,001 m/s
-----------------------------	-----------