

535835 SKF

Radial shaft seals

TYPE: Radial shaft seals, Metal case, Springless sealing lip, Type HM3, material FPM/FKM (SKF)

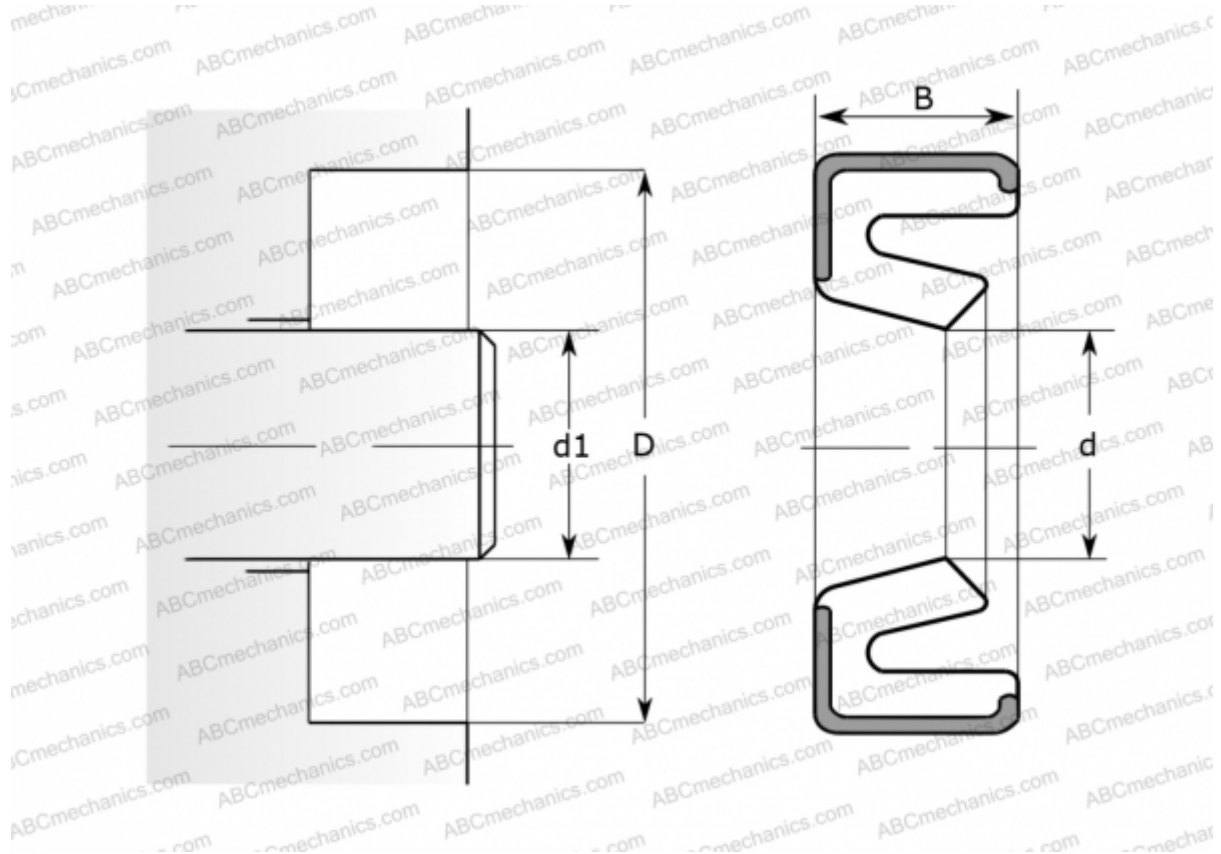

Technical specification

DIMENSIONS, MM

d1	9,525
d	9,525
D	14,275
B	2,362

MANUFACTURER [SKF](#)

INTERCHANGE

CR [CR 535835](#)

CALCULATION DATA

Operating temperature min	-40 °C
Operating temperature max	200 °C
Pressure differential max	0,070 Mpa
Maximum shaft surface speed	6,000 m/s