

CR 6106 CR

Radial shaft seals

TYPE: Radial shaft seals, Metal case, Springless sealing lip, Type HM3, material FPM/FKM (SKF)

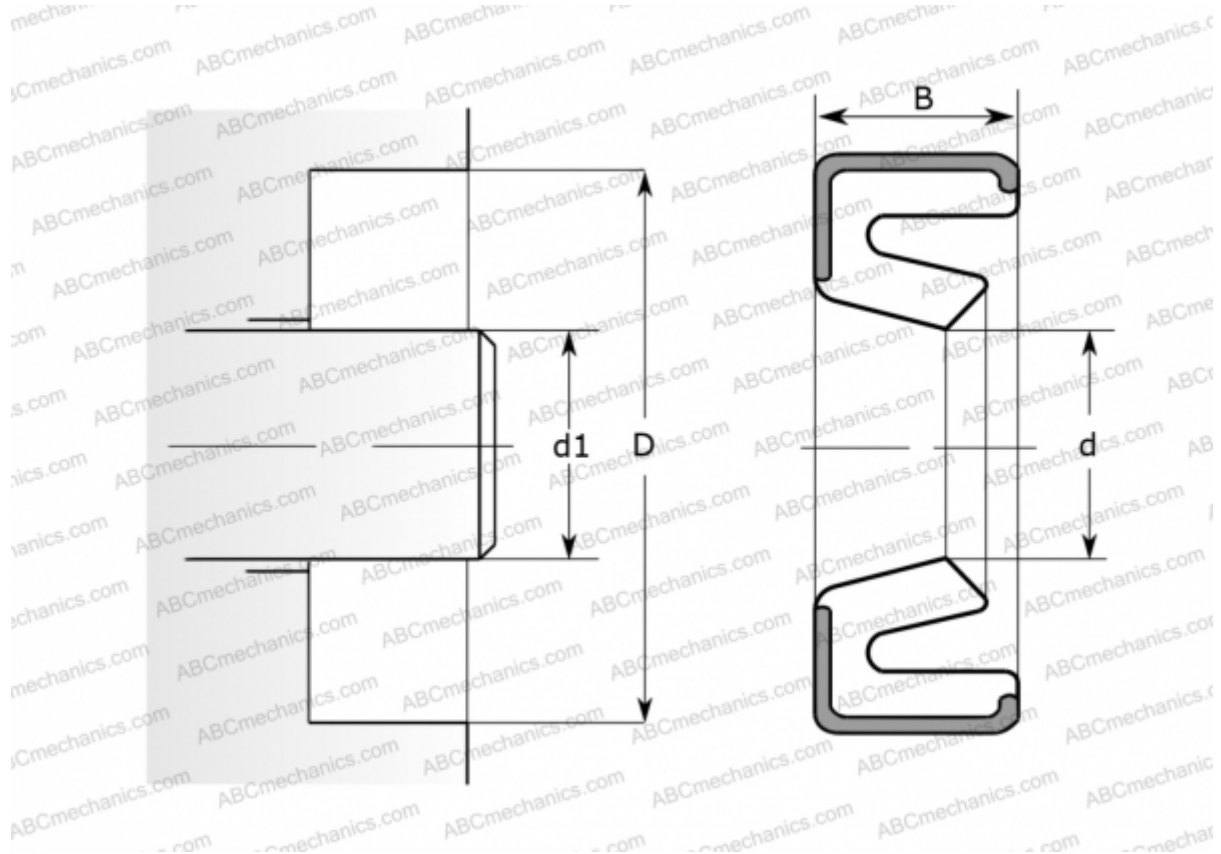

Technical specification

DIMENSIONS, MM

d1	15,875
d	15,875
D	20,650
B	2,388

MANUFACTURER [CR](#)

INTERCHANGE

SKF [6106](#)

CALCULATION DATA

Operating temperature min	-40 °C
Operating temperature max	200 °C
Pressure differential max	0,070 Mpa
Maximum shaft surface speed	6,000 m/s