

15x21x3 HM4 R SKF

Radial shaft seals

TYPE: Radial shaft seals, Metal case, Springless sealing lip, Type HM4, material NBR (SKF)

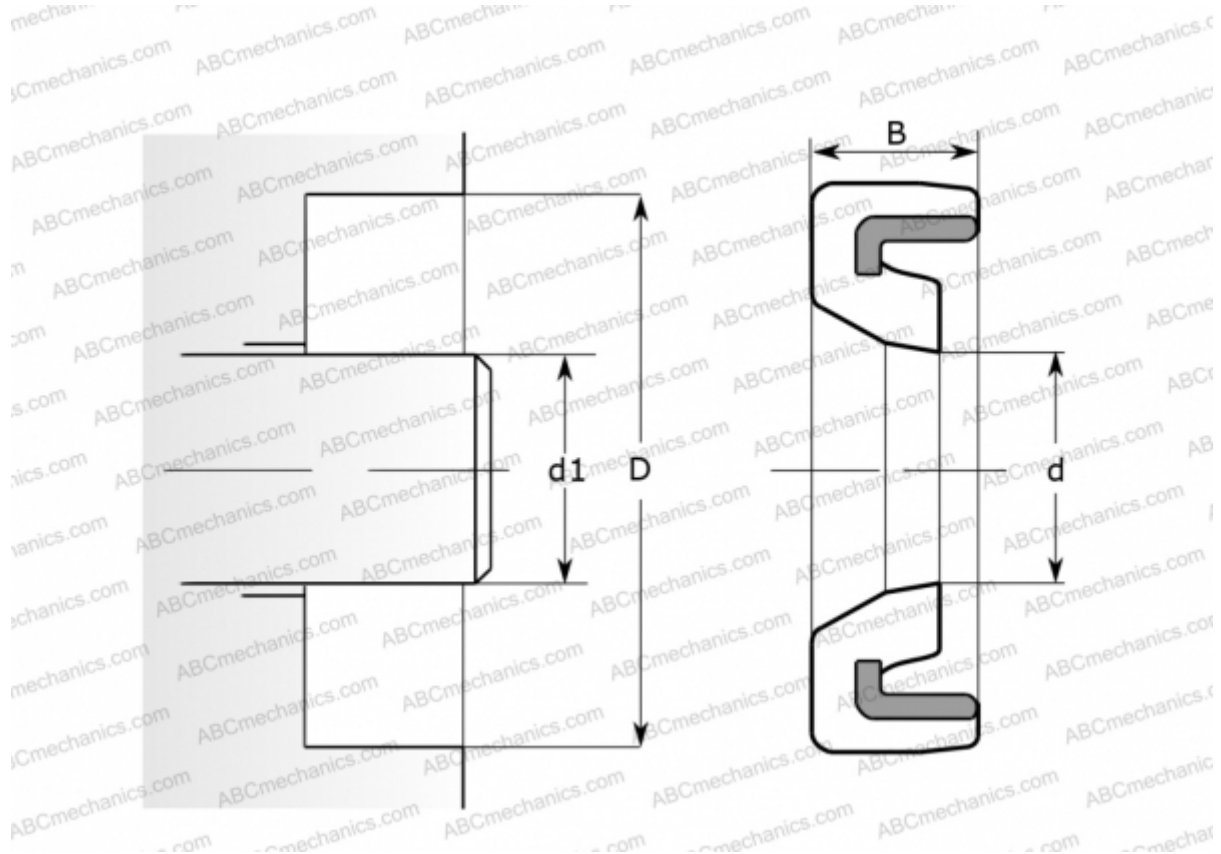

Technical specification

DIMENSIONS, MM

d_1	15,000
d	15,000
D	21,000
B	3,000

MANUFACTURER

[SKF](#)

INTERCHANGE

CR	CR 15x21x3 HM4 R
----	----------------------------------

CALCULATION DATA

Operating temperature min	-40 °C
Operating temperature max	100 °C
Pressure differential max	0,070 Mpa
Maximum shaft surface speed	0,001 m/s