

CR 25x32x4 HM4 R CR

Radial shaft seals

TYPE: Radial shaft seals, Metal case, Springless sealing lip, Type HM4, material NBR (SKF)

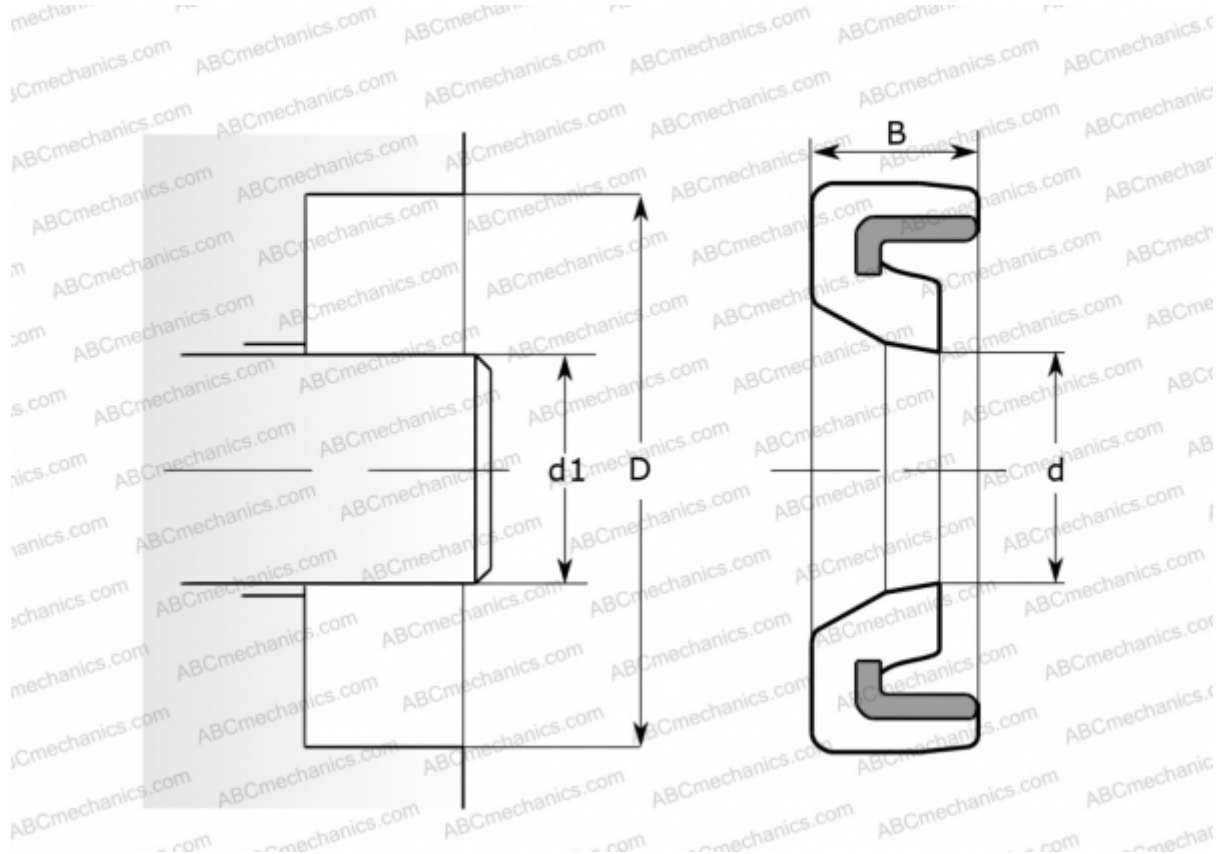

Technical specification

DIMENSIONS, MM

d1	25,000
d	25,000
D	32,000
B	4,000

MANUFACTURER [CR](#)

INTERCHANGE

SKF	25x32x4 HM4 R
-----	-------------------------------

CALCULATION DATA

Operating temperature min	-40 °C
Operating temperature max	100 °C
Pressure differential max	0,070 Mpa
Maximum shaft surface speed	0,001 m/s