

## 30x37x4 HM4 R SKF

Radial shaft seals

TYPE: Radial shaft seals, Metal case, Springless sealing lip, Type HM4, material NBR (SKF)

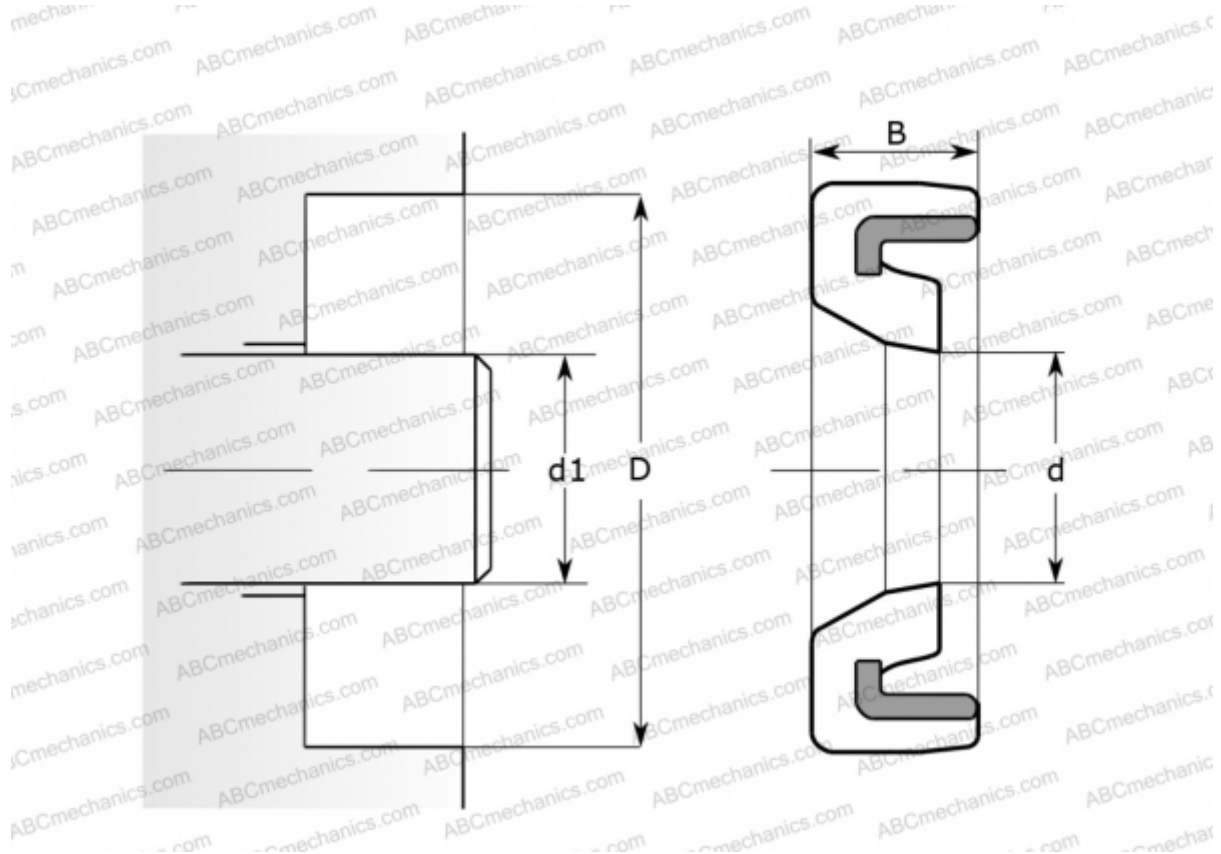

### Technical specification

#### DIMENSIONS, MM

$d_1$	30,000
$d$	30,000
$D$	37,000
$B$	4,000

**MANUFACTURER** [SKF](#)

#### INTERCHANGE

CR [CR 30x37x4 HM4 R](#)

#### CALCULATION DATA

Operating temperature min	-40 °C
Operating temperature max	100 °C
Pressure differential max	0,070 Mpa
Maximum shaft surface speed	0,001 m/s