

## CR 30x37x4 HM4 R CR

Radial shaft seals

TYPE: Radial shaft seals, Metal case, Springless sealing lip, Type HM4, material NBR (SKF)

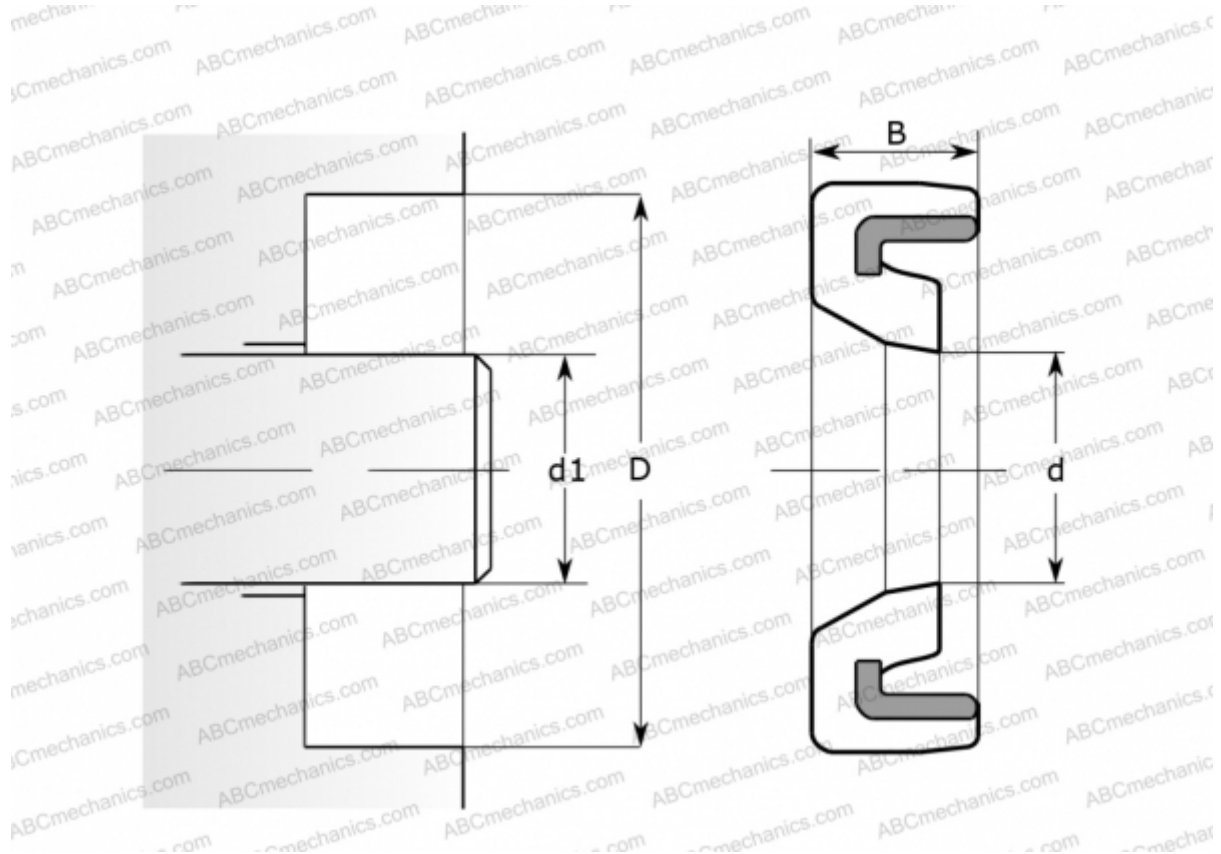

### Technical specification

#### DIMENSIONS, MM

d1	30,000
d	30,000
D	37,000
B	4,000

**MANUFACTURER** [CR](#)

#### INTERCHANGE

SKF	<a href="#">30x37x4 HM4 R</a>
-----	-------------------------------

#### CALCULATION DATA

Operating temperature min	-40 °C
Operating temperature max	100 °C
Pressure differential max	0,070 Mpa
Maximum shaft surface speed	0,001 m/s