

16069 SKF

Radial shaft seals

TYPE: Radial shaft seals, Metal case, Springless sealing lip, Type HM18, material NBR (SKF)

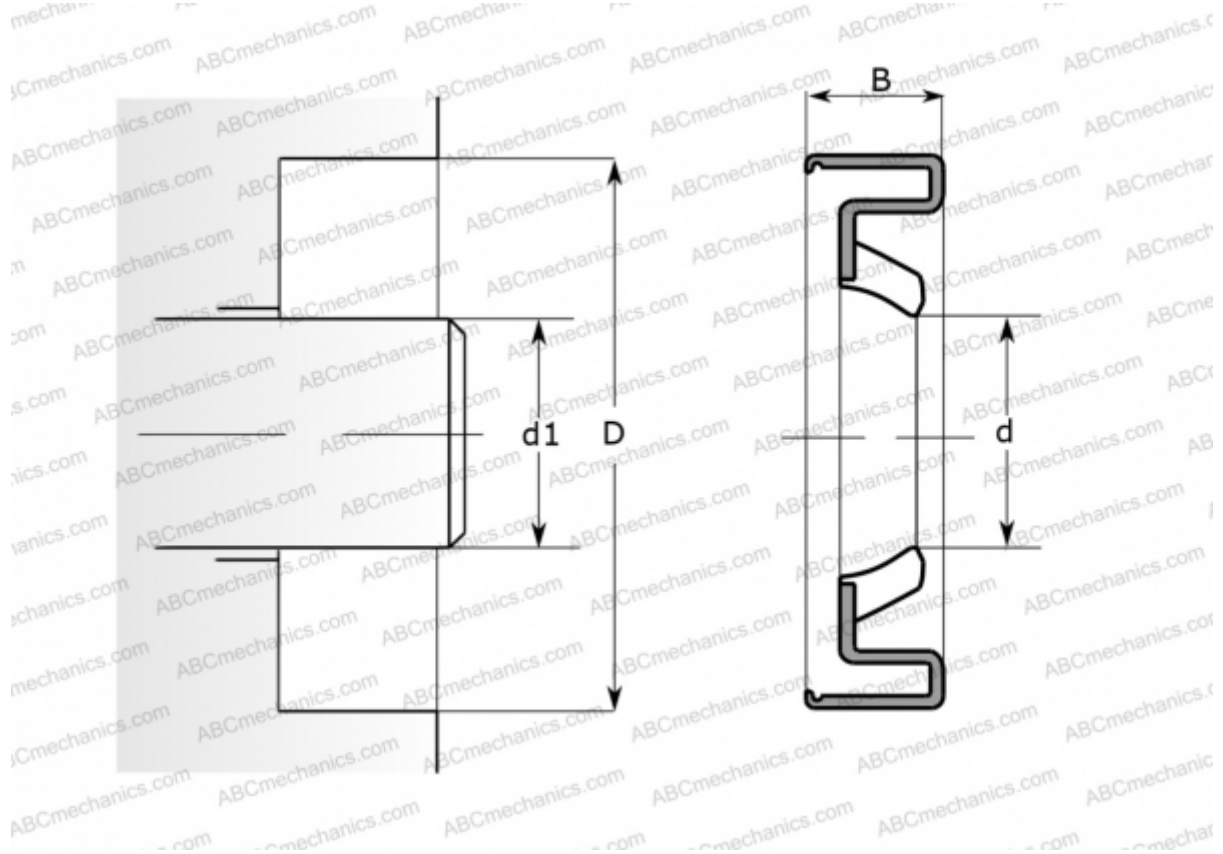

Technical specification

DIMENSIONS, MM

d1	41,275
d	41,275
D	59,131
B	11,125

MANUFACTURER [SKF](#)

INTERCHANGE

CR [CR 16069](#)

CALCULATION DATA

Operating temperature min	-40 °C
Operating temperature max	100 °C
Permissible operating temperature, short periods max	120 °C
Pressure differential max	0,070 Mpa
Maximum shaft surface speed	6,000 m/s