

## CR 16667 CR

Radial shaft seals

TYPE: Radial shaft seals, Metal case, Springless sealing lip, Type HM18, material NBR (SKF)

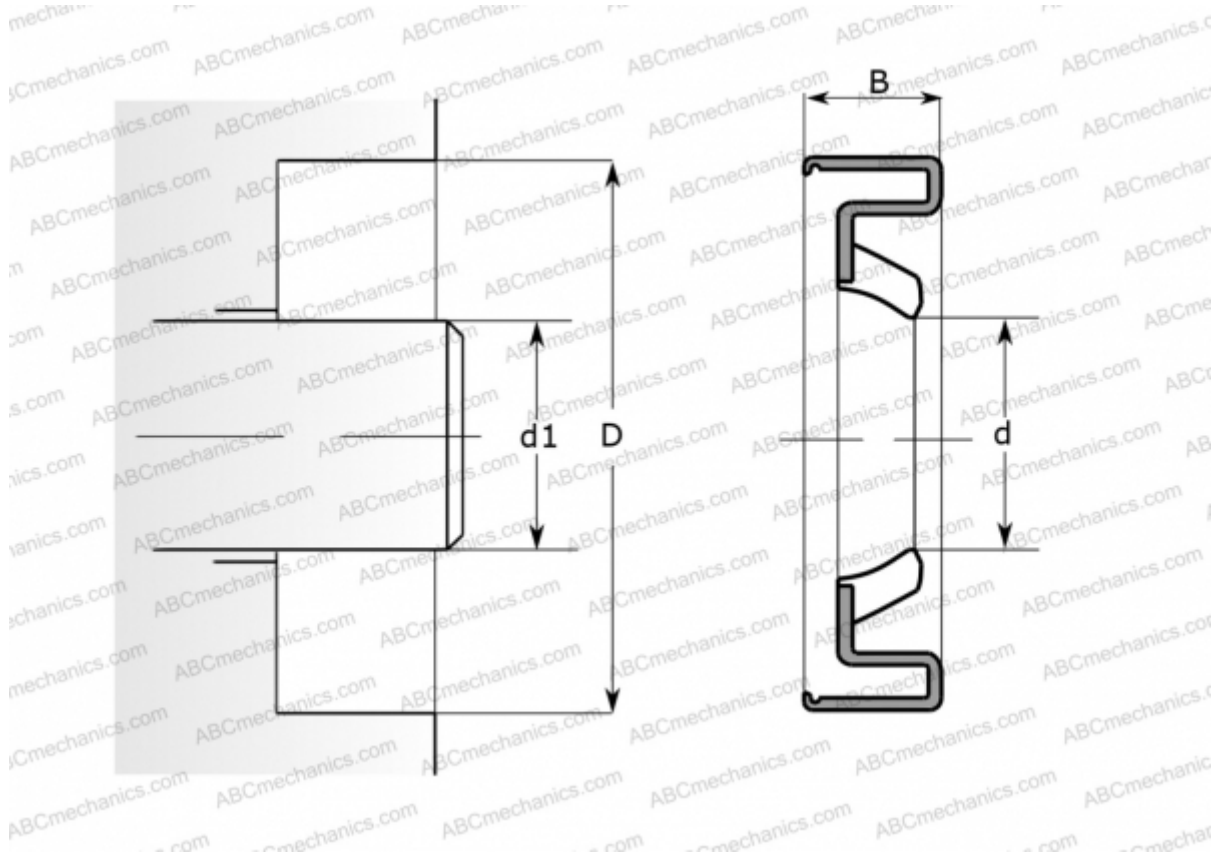

### Technical specification

#### DIMENSIONS, MM

d1	42,875
d	42,875
D	59,131
B	12,700

**MANUFACTURER** [CR](#)

#### INTERCHANGE

SKF	<a href="#">16667</a>
-----	-----------------------

#### CALCULATION DATA

Operating temperature min	-40 °C
Operating temperature max	100 °C
Permissible operating temperature, short periods max	120 °C
Pressure differential max	0,070 Mpa
Maximum shaft surface speed	6,000 m/s