

## 11161 SKF

Radial shaft seals

TYPE: Radial shaft seals, Metal case, Springless sealing lip, Type HM21, material NBR (SKF)

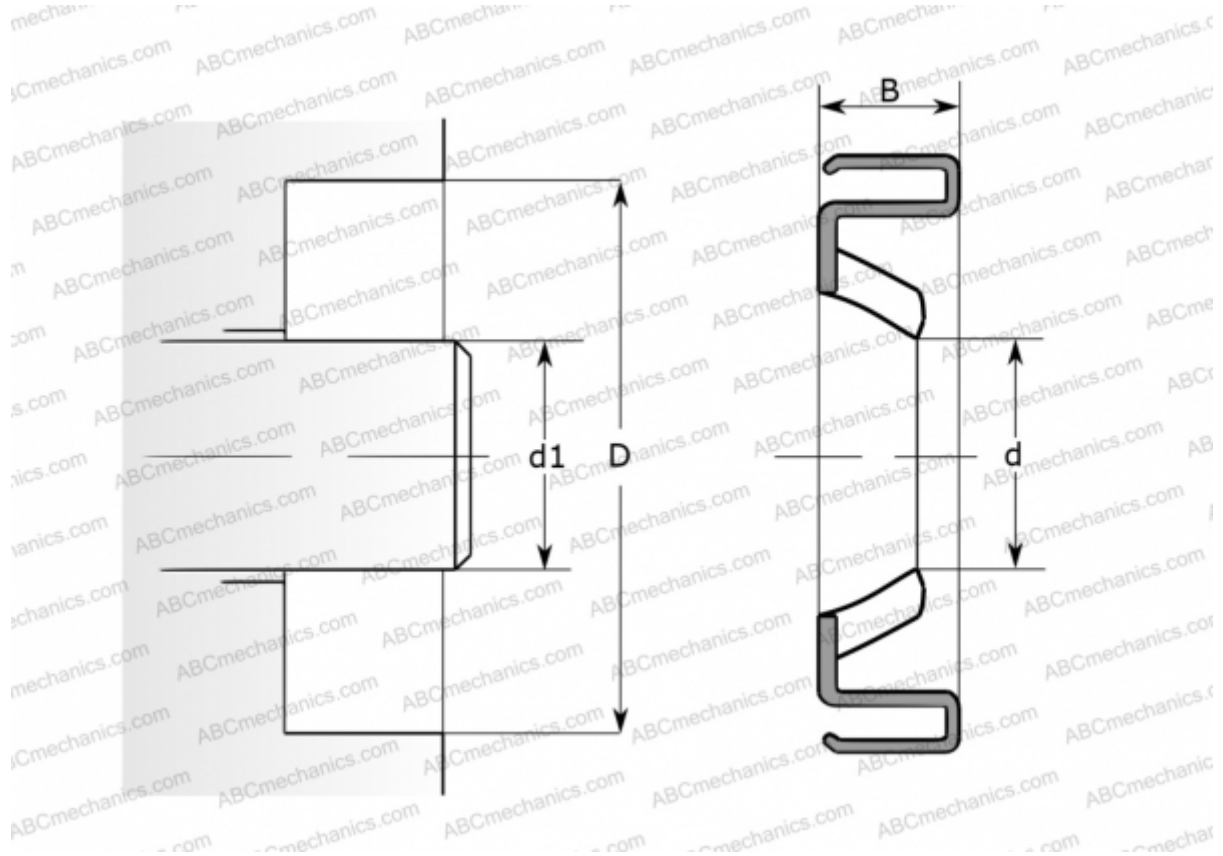

### Technical specification

#### DIMENSIONS, MM

d1	28,575
d	28,575
D	45,237
B	6,350

#### MANUFACTURER

[SKF](#)

#### INTERCHANGE

CR	<a href="#">CR 11161</a>
----	--------------------------

#### CALCULATION DATA

Operating temperature min	-40 °C
Operating temperature max	100 °C
Permissible operating temperature, short periods max	120 °C
Pressure differential max	0,070 Mpa
Maximum shaft surface speed	6,000 m/s