

## CR 17702 CR

Radial shaft seals

TYPE: Radial shaft seals, Metal case, Springless sealing lip, Type HM21, material NBR (SKF)

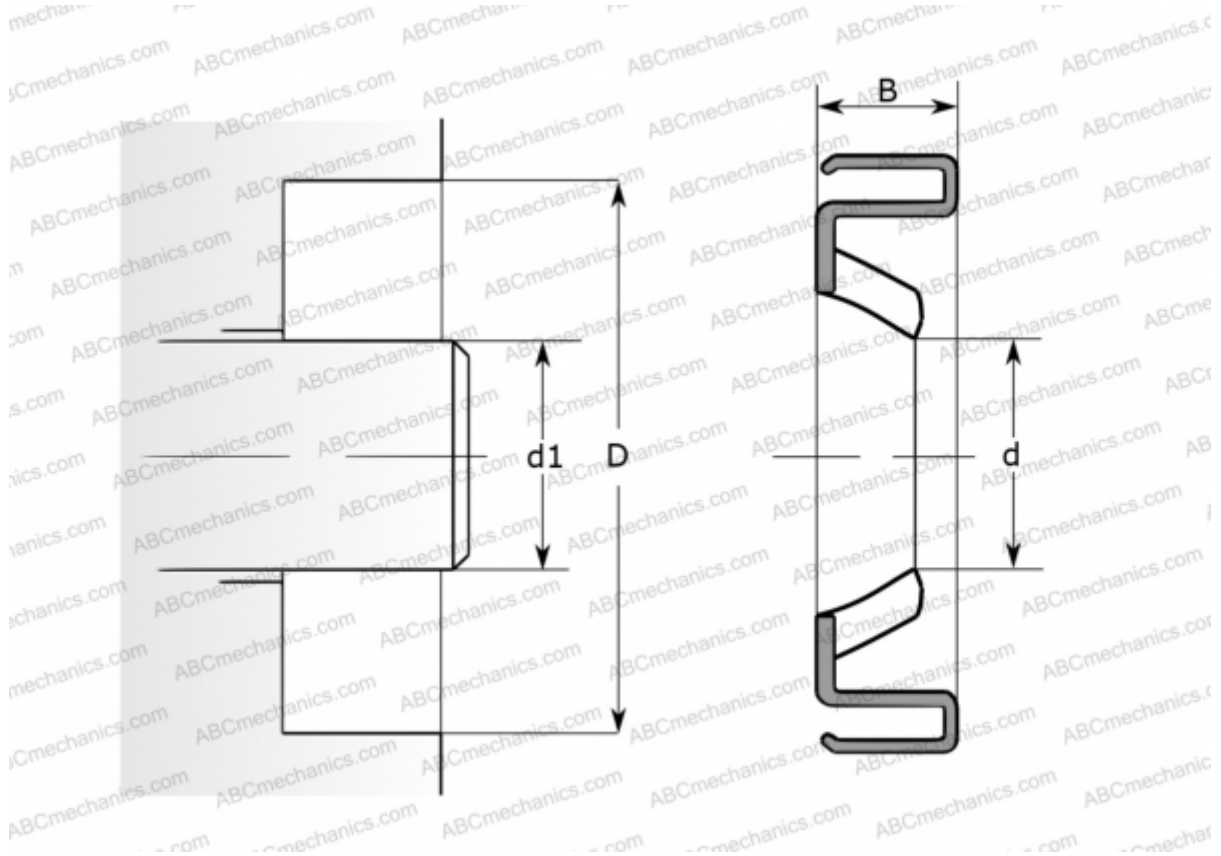

### Technical specification

#### DIMENSIONS, MM

d1	44,450
d	44,450
D	76,200
B	6,350

**MANUFACTURER** [CR](#)

#### INTERCHANGE

SKF	<a href="#">17702</a>
-----	-----------------------

#### CALCULATION DATA

Operating temperature min	-40 °C
Operating temperature max	100 °C
Permissible operating temperature, short periods max	120 °C
Pressure differential max	0,070 Mpa
Maximum shaft surface speed	6,000 m/s