

26260 SKF

Radial shaft seals

TYPE: Radial shaft seals, Metal case, Springless sealing lip, Type HM21, material NBR (SKF)

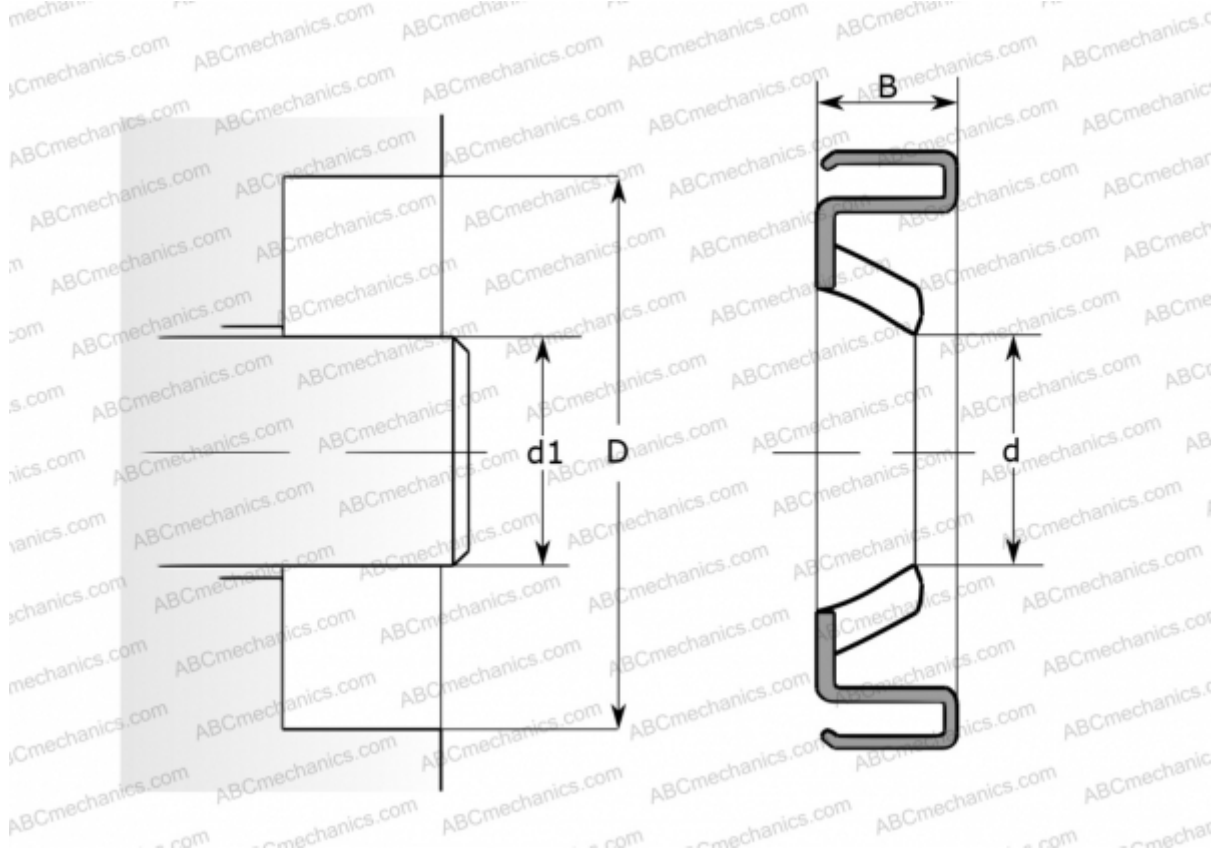

Technical specification

DIMENSIONS, MM

d1	66,675
d	66,675
D	92,024
B	6,350

MANUFACTURER

[SKF](#)

INTERCHANGE

CR	CR 26260
----	--------------------------

CALCULATION DATA

Operating temperature min	-40 °C
Operating temperature max	100 °C
Permissible operating temperature, short periods max	120 °C
Pressure differential max	0,070 Mpa
Maximum shaft surface speed	6,000 m/s