

CR 95052 CR

Radial shaft seals

TYPE: Radial shaft seals, Metal case, Springless sealing lip, Type HM21, material NBR (SKF)

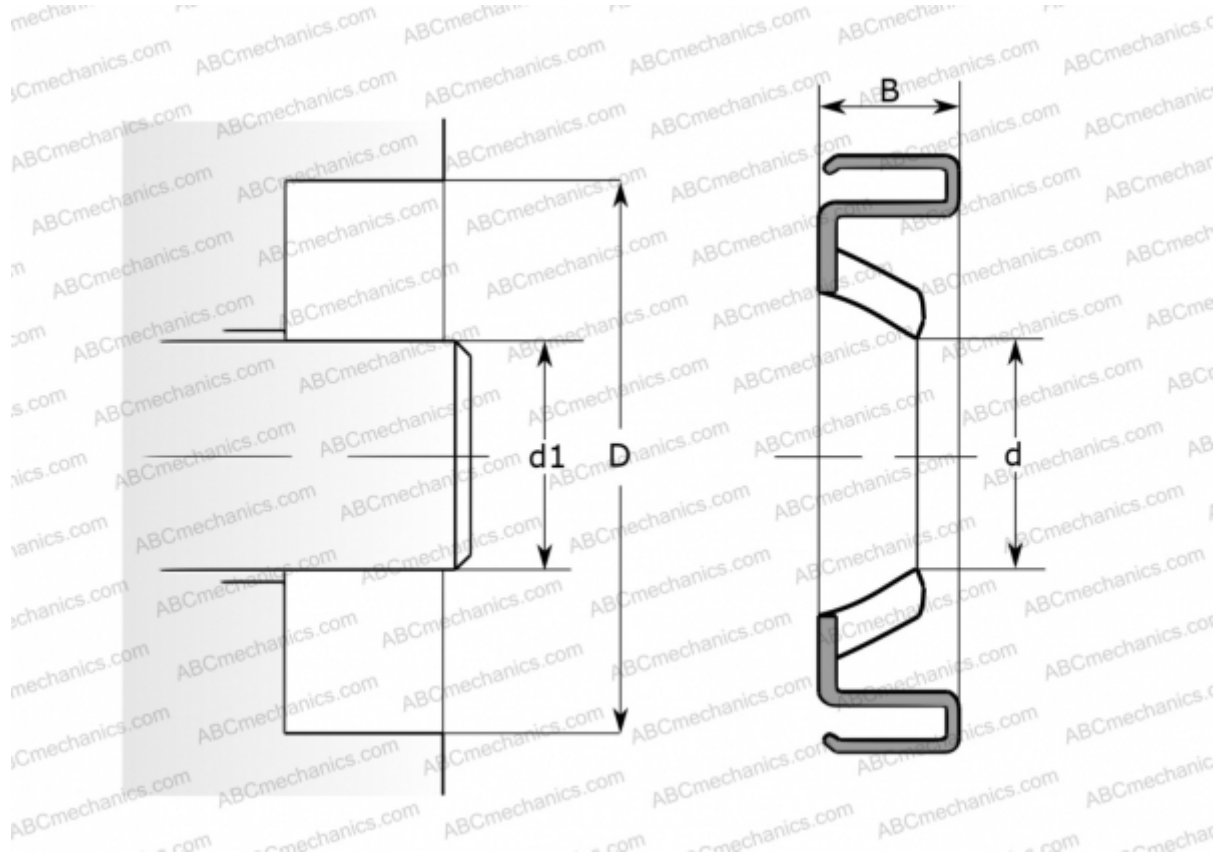

Technical specification

DIMENSIONS, MM

d1	241,300
d	241,300
D	273,050
B	7,950

MANUFACTURER [CR](#)

INTERCHANGE

SKF	95052
-----	-----------------------

CALCULATION DATA

Operating temperature min	-40 °C
Operating temperature max	100 °C
Permissible operating temperature, short periods max	120 °C
Pressure differential max	0,070 Mpa
Maximum shaft surface speed	6,000 m/s