

## 42x64x6 HMA1 R SKF

Radial shaft seals

TYPE: Radial shaft seals, Metal case, Springless sealing lip, Type HMA1, material NBR (SKF)

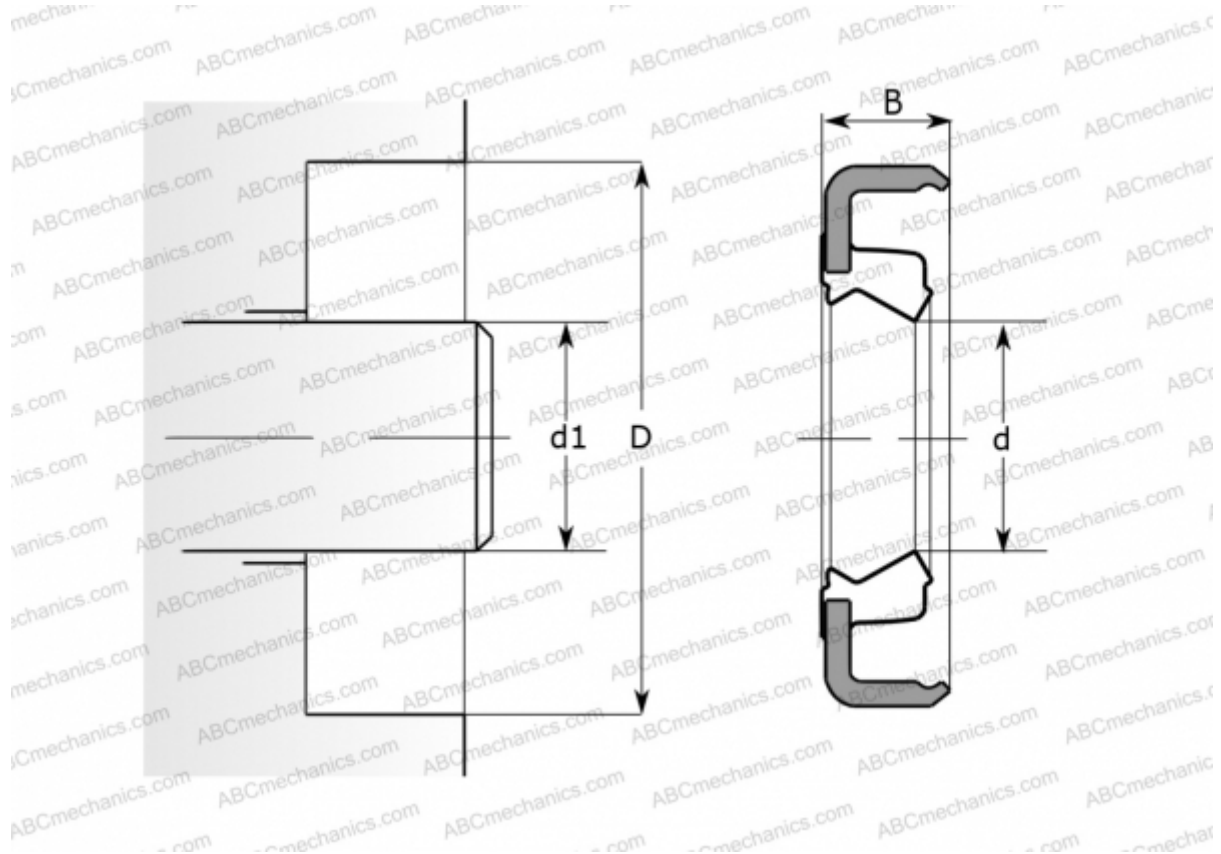

### Technical specification

#### DIMENSIONS, MM

d1	42,000
d	42,000
D	64,000
B	6,000

**MANUFACTURER** [SKF](#)

#### INTERCHANGE

CR [CR 42x64x6 HMA1 R](#)

#### CALCULATION DATA

Operating temperature min	-40 °C
Operating temperature max	100 °C
Permissible operating temperature, short periods max	120 °C
Maximum shaft surface speed	0,001 m/s