

CR 31192 CR

Radial shaft seals

TYPE: Radial shaft seals, Metal case, Springless sealing lip, Type HMA1, material NBR (SKF)

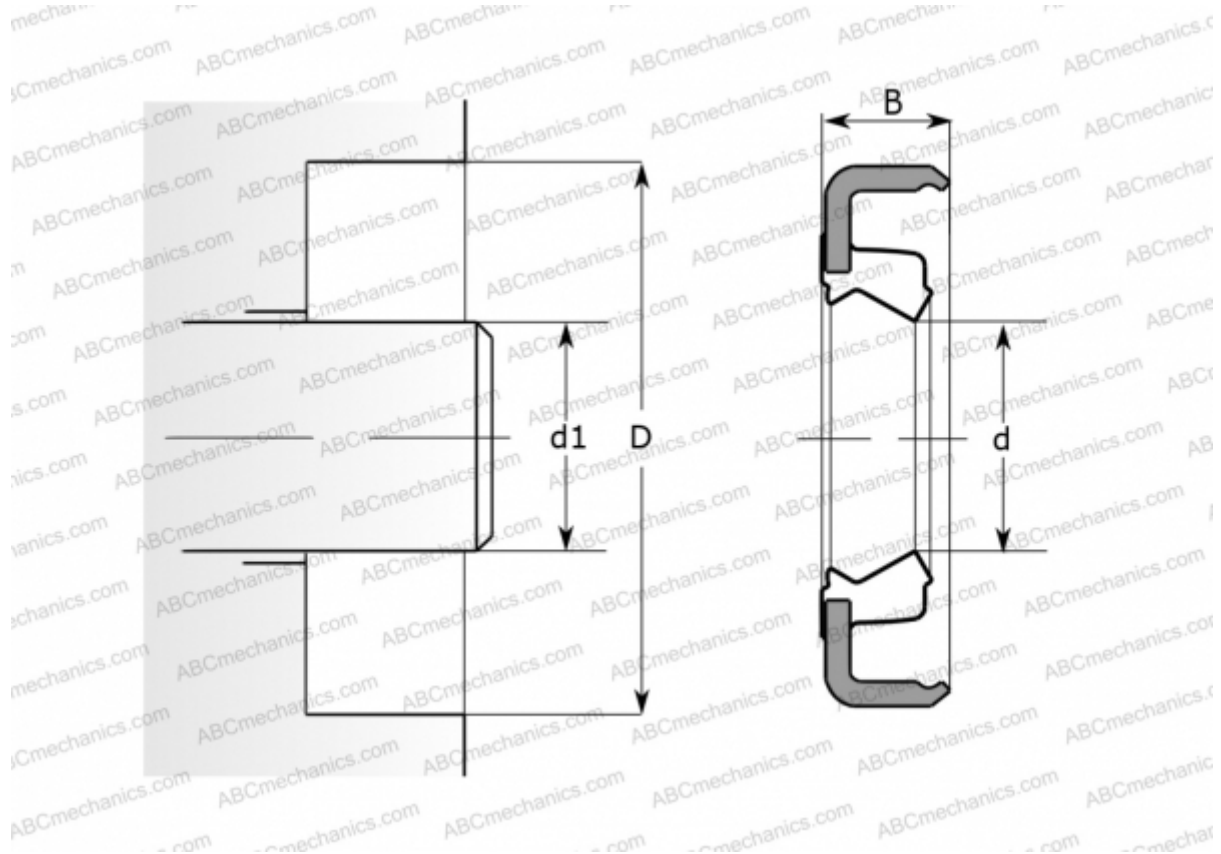

Technical specification

DIMENSIONS, MM

d1	79,375
d	79,375
D	104,775
B	6,350

MANUFACTURER [CR](#)

INTERCHANGE

SKF	31192
-----	-----------------------

CALCULATION DATA

Operating temperature min	-40 °C
Operating temperature max	100 °C
Permissible operating temperature, short periods max	120 °C
Maximum shaft surface speed	0,001 m/s