

32325 SKF

Radial shaft seals

TYPE: Radial shaft seals, Metal case, Springless sealing lip, Type HMA1, material NBR (SKF)

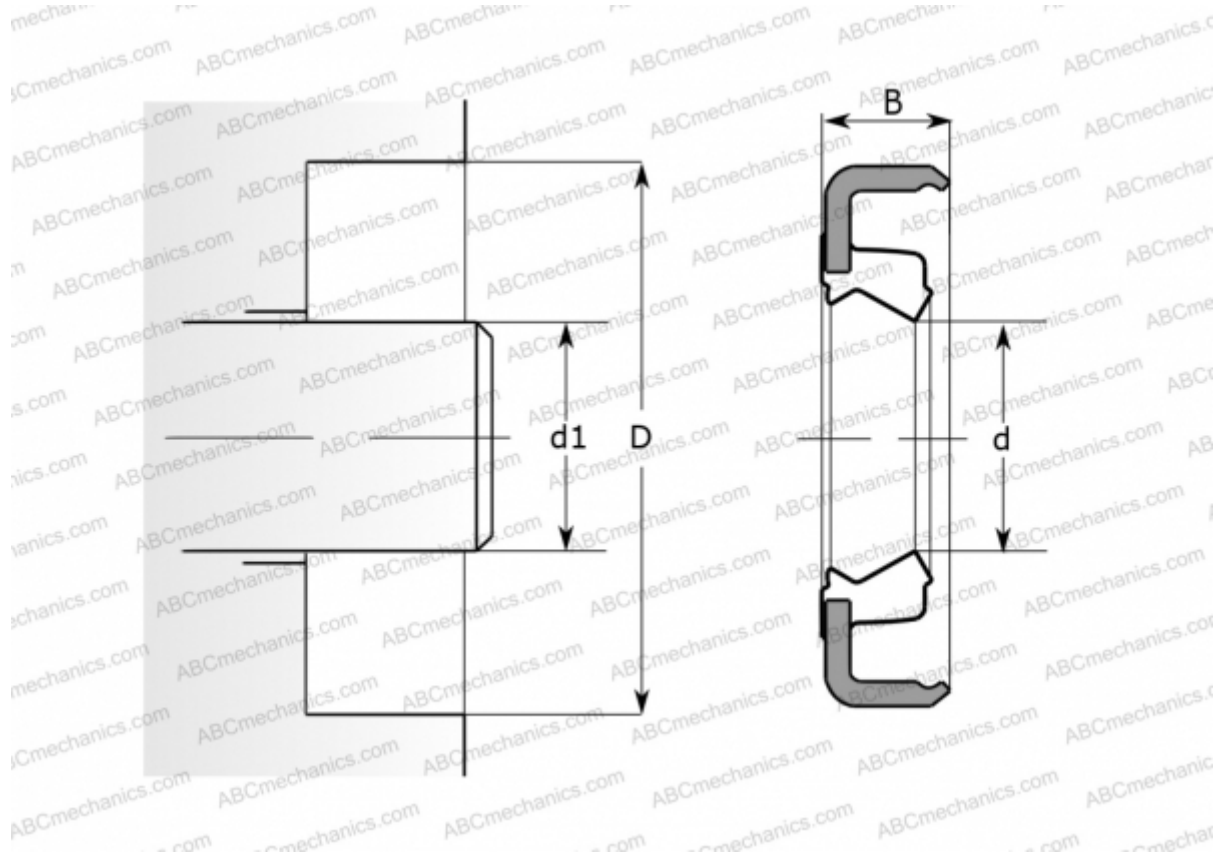

Technical specification

DIMENSIONS, MM

d1	82,550
d	82,550
D	95,250
B	6,350

MANUFACTURER [SKF](#)

INTERCHANGE

CR [CR 32325](#)

CALCULATION DATA

Operating temperature min	-40 °C
Operating temperature max	100 °C
Permissible operating temperature, short periods max	120 °C
Maximum shaft surface speed	0,001 m/s