

CR 14600 CR

Radial shaft seals

TYPE: Radial shaft seals, Metal case, Springless sealing lip, Type HMA11, material NBR (SKF)

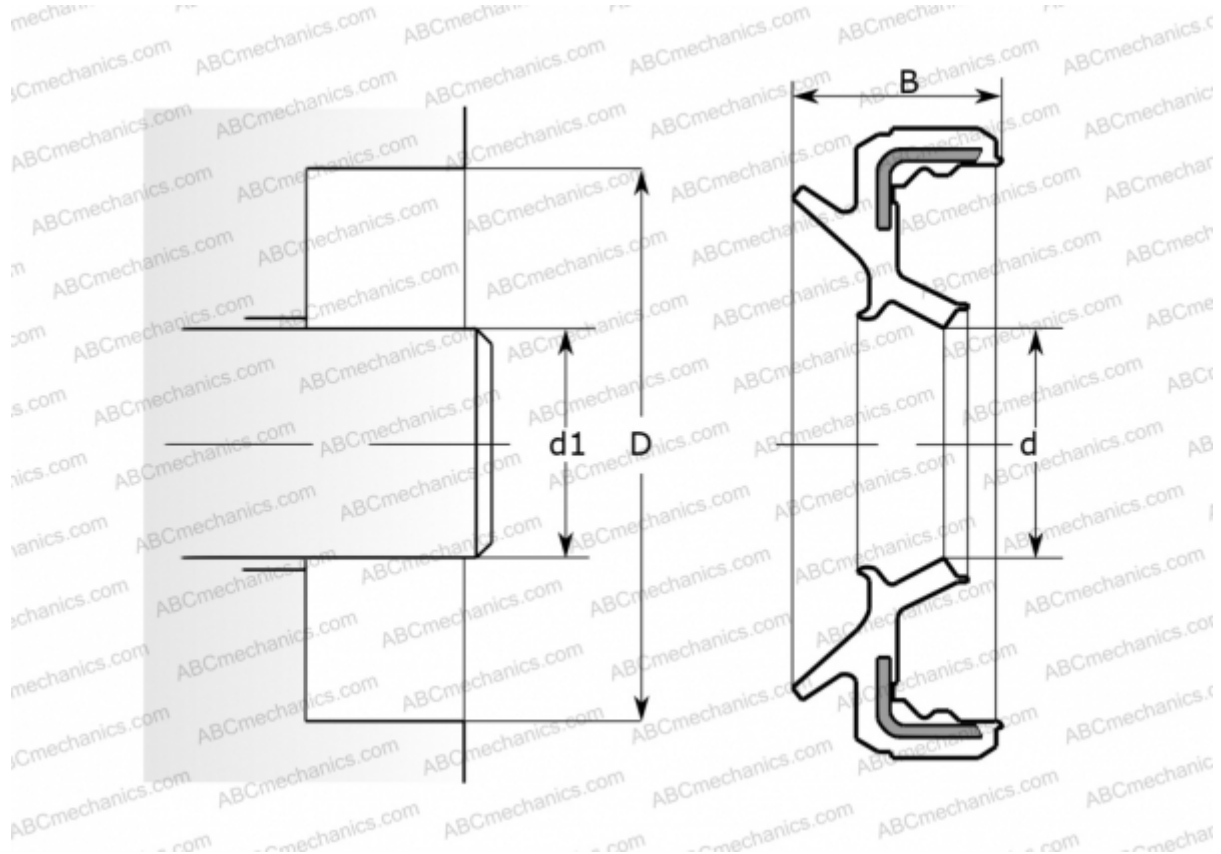

Technical specification

DIMENSIONS, MM

d1	37,008
d	37,008
D	51,994
B	8,331

MANUFACTURER [CR](#)

INTERCHANGE

SKF	14600
-----	-----------------------

CALCULATION DATA

Operating temperature min	-40 °C
Operating temperature max	100 °C
Permissible operating temperature, short periods max	120 °C
Maximum shaft surface speed	0,001 m/s