

CR 45x72x8 HMA22 R CR

Radial shaft seals

TYPE: Radial shaft seals, Metal case, Springless sealing lip, Type HMA22, material NBR (SKF)

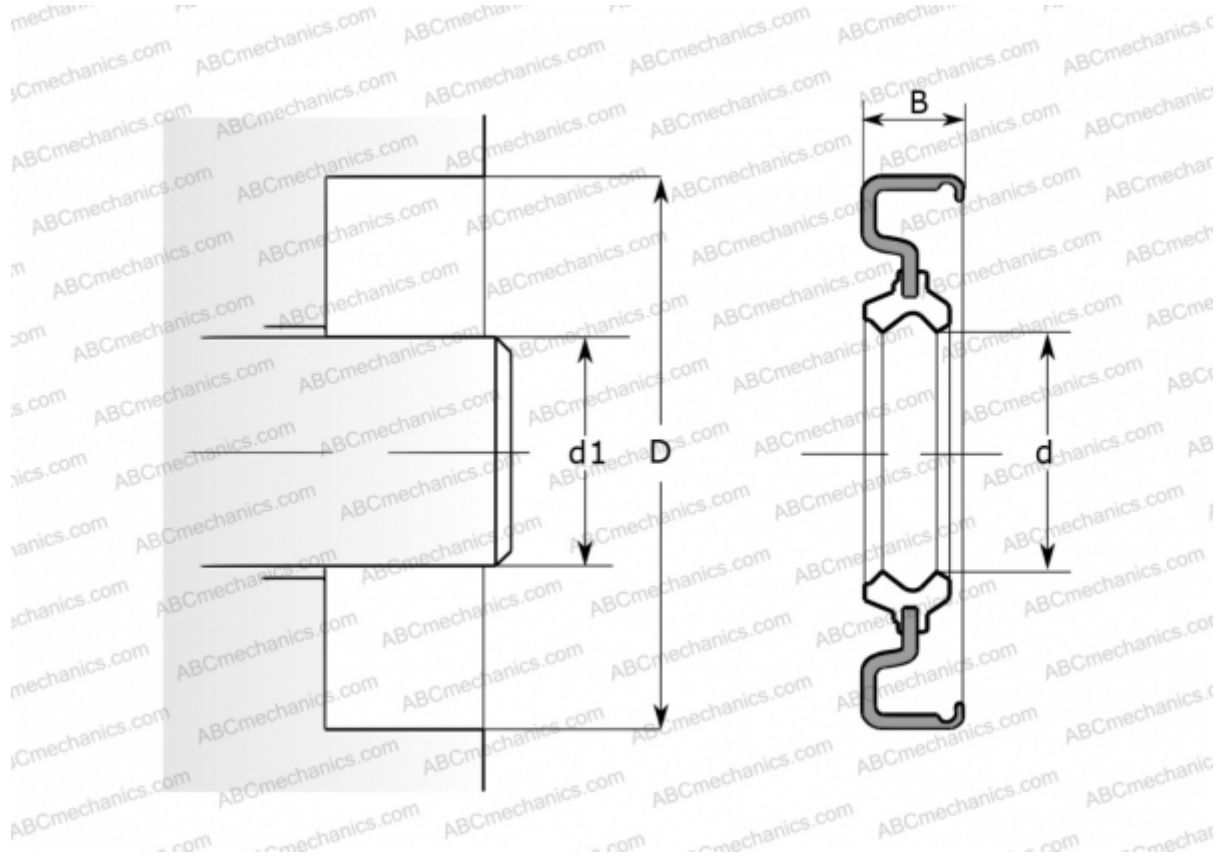

Technical specification

DIMENSIONS, MM

d1	45,000
d	45,000
D	72,000
B	8,000

MANUFACTURER [CR](#)

INTERCHANGE

SKF	45x72x8 HMA22 R
-----	---------------------------------

CALCULATION DATA

Operating temperature min	-40 °C
Operating temperature max	100 °C
Permissible operating temperature, short periods max	120 °C
Pressure differential max	0,070 Mpa
Maximum shaft surface speed	0,001 m/s