

CR 40x53x5 HMA76 R CR

Radial shaft seals

TYPE: Radial shaft seals, Metal case, Springless sealing lip, Type HMA76, material NBR (SKF)

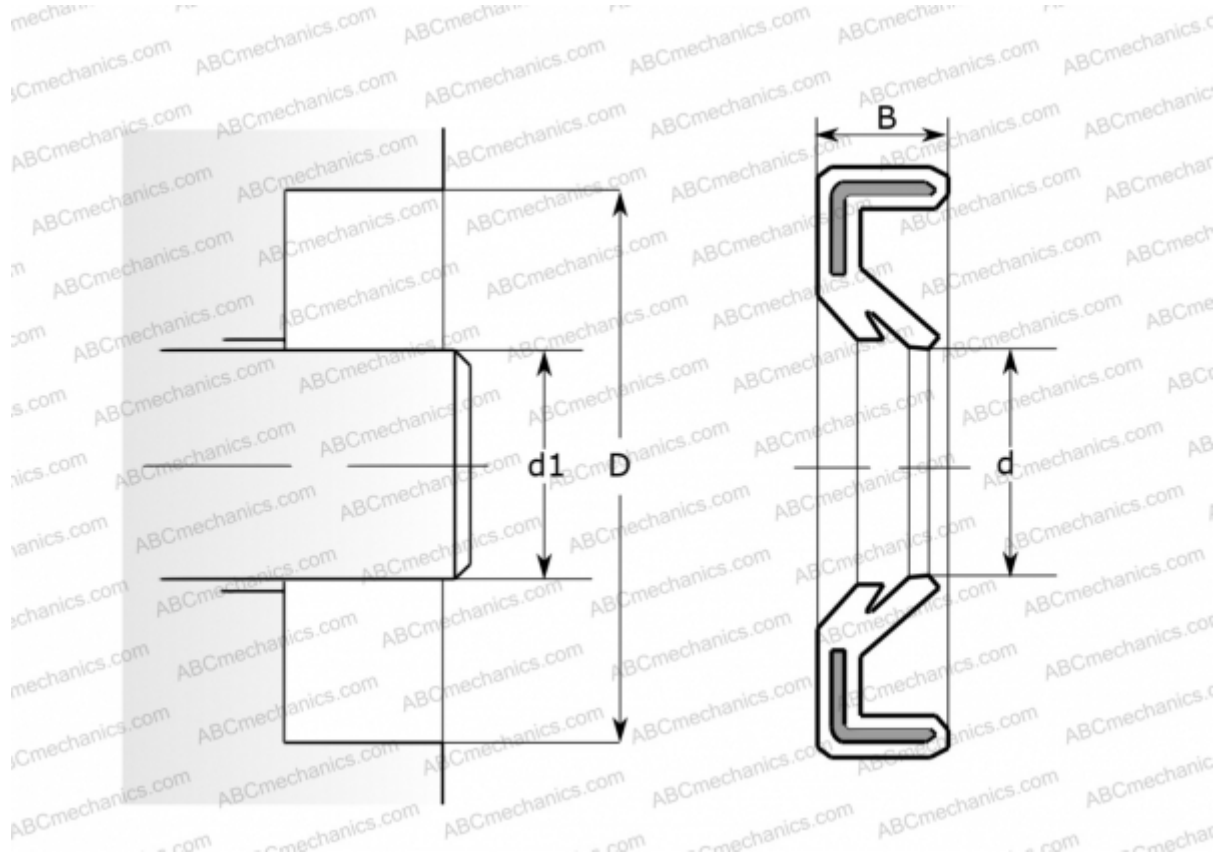

Technical specification

DIMENSIONS, MM

d1	40,000
d	40,000
D	53,000
B	5,000

MANUFACTURER [CR](#)

INTERCHANGE

SKF	40x53x5 HMA76 R
-----	---------------------------------

CALCULATION DATA

Operating temperature min	-40 °C
Operating temperature max	100 °C
Permissible operating temperature, short periods max	120 °C
Pressure differential max	0,070 Mpa
Maximum shaft surface speed	0,001 m/s