

CR 26310 CR

Radial shaft seals

TYPE: Radial shaft seals, Metal case, Springless sealing lip, Type TL5, material NBR (SKF)

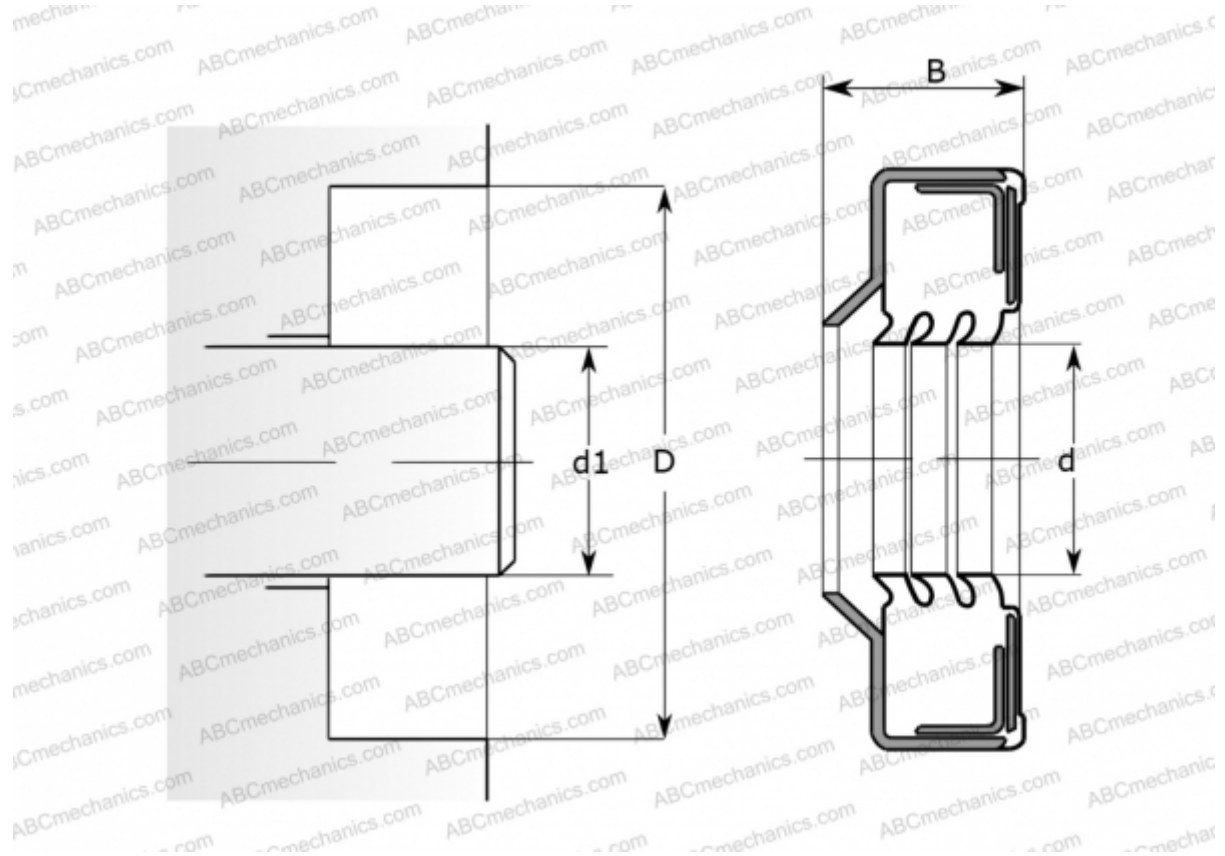

Technical specification

DIMENSIONS, MM

d1	66,675
d	66,675
D	96,850
B	10,541

MANUFACTURER [CR](#)

INTERCHANGE

SKF	26310
-----	-----------------------

CALCULATION DATA

Operating temperature min	-40 °C
Operating temperature max	100 °C
Permissible operating temperature, short periods max	120 °C
Pressure differential max	0,070 Mpa
Maximum shaft surface speed	9,000 m/s