

CR 19620 CR

Radial shaft seals

TYPE: Radial shaft seals, Metal case and a secondary reinforcement in the side face, With spring-loaded sealing slip, Type CRSH1, material ACM (SKF)

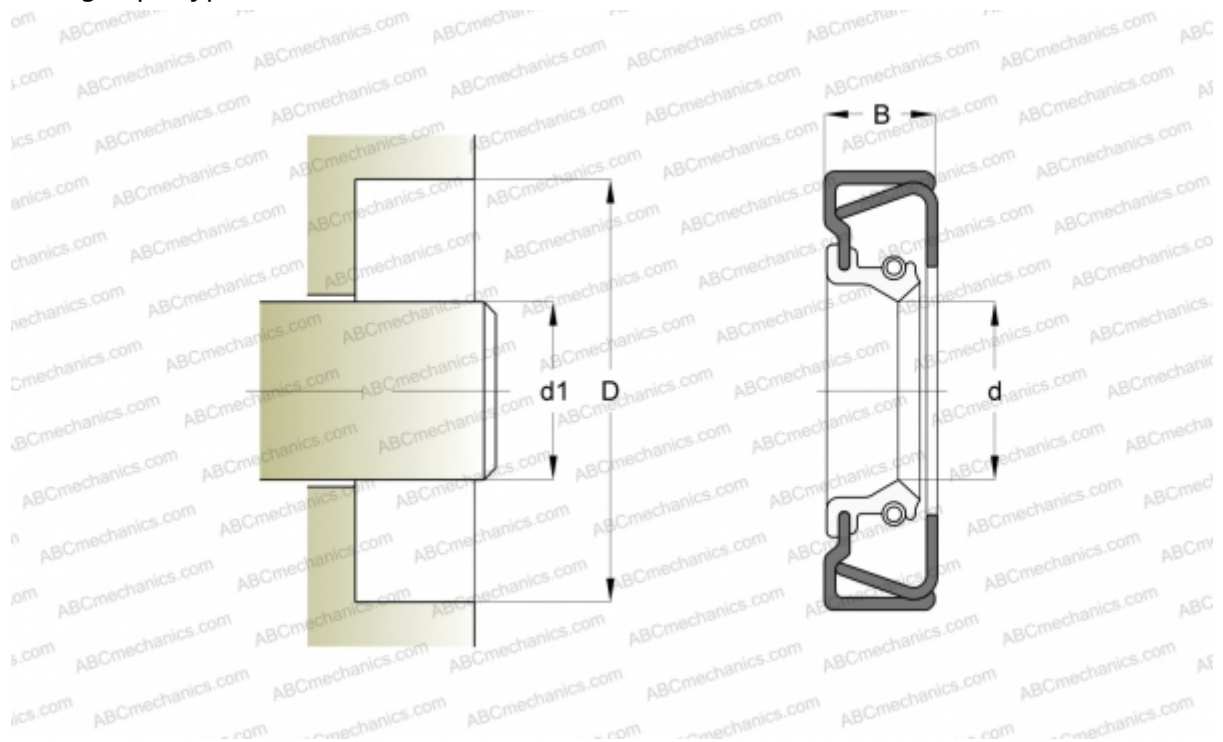

Technical specification

DIMENSIONS, MM

d1	50,013
d	50,013
D	69,647
B	12,700

MANUFACTURER [CR](#)

INTERCHANGE

SKF	19620
-----	-----------------------

CALCULATION DATA

Operating temperature min	-40 °C
Operating temperature max	150 °C
Permissible operating temperature, short periods max	170 °C
Pressure differential max	0,070 Mpa
Maximum shaft surface speed	14,510 m/s